

Anisotropes Materialverhalten über kurz oder lang zur Materialkarte

P. Reithofer, B. Jilka, A. Fertschej, M. Rollant
4a engineering GmbH, Traboch, Austria

Composite Infotag 13.3.2017 Stuttgart

The logo for DYNAMORE, with 'DYNA' in a large, bold, black font and 'MORE' in a smaller, blue, sans-serif font below it. To the left of 'DYNA' is a blue square with a white diagonal line.

- Introduction 4a engineering & 4a impetus
- Short overview composites
- Short & long fiber reinforced thermoplastics
 - Material behavior
 - ***MAT_24** - state of the art
 - ***MAT_157** - „key enabler“ micro mechanic
 - ***MAT_215** - micromechanical material model
- Endless fiber reinforced composites
- Summary

4a engineering GmbH

4a impetus

- polymer and materials science
- numerical simulation methods
- fiber reinforced plastics and composites
- method and software development
- material characterization
- product development

strut bar:



LH₂ – tank mounting:

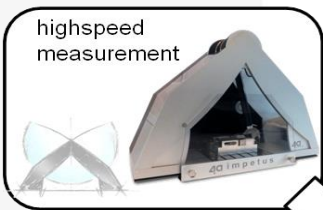
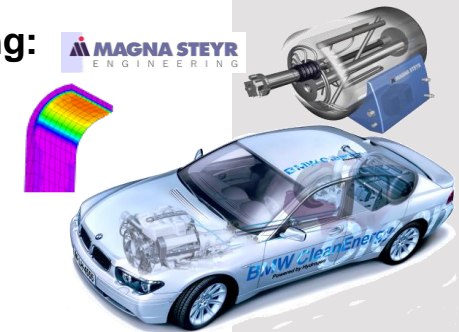

parameterized materialcard

$$\sigma = \sigma_0 + E \cdot \epsilon_p \cdot \left[1 - \frac{E}{H} \cdot \epsilon_p \right]$$

$$\sigma = \sigma_0(\epsilon) \left[1 + C \ln \frac{\epsilon}{\epsilon_0} \right]$$

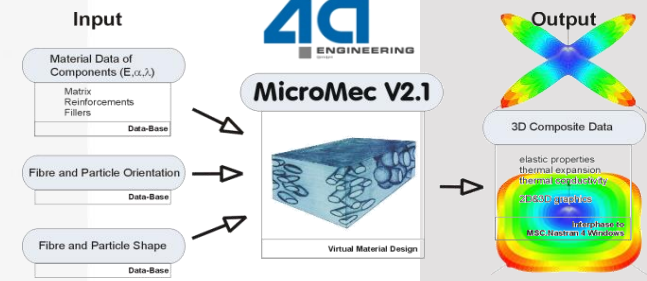
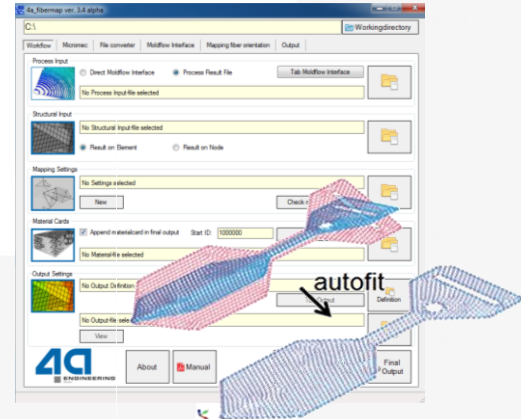
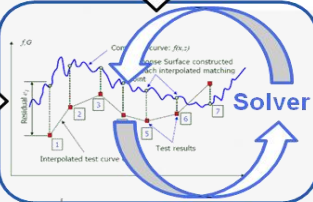
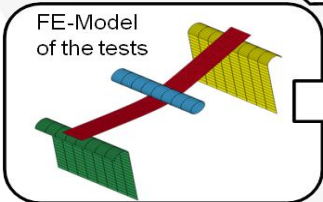

- efficient high-dynamic testing
- crash-behaviour of plastics
- material data for simulation



source: <http://gm-volt.com/>

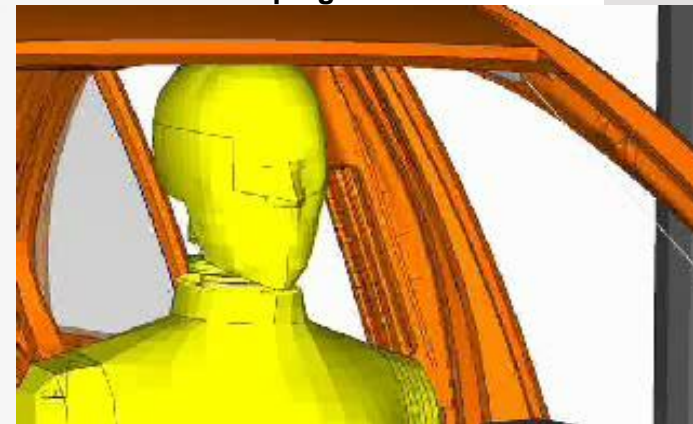

source: Dynamore GmbH

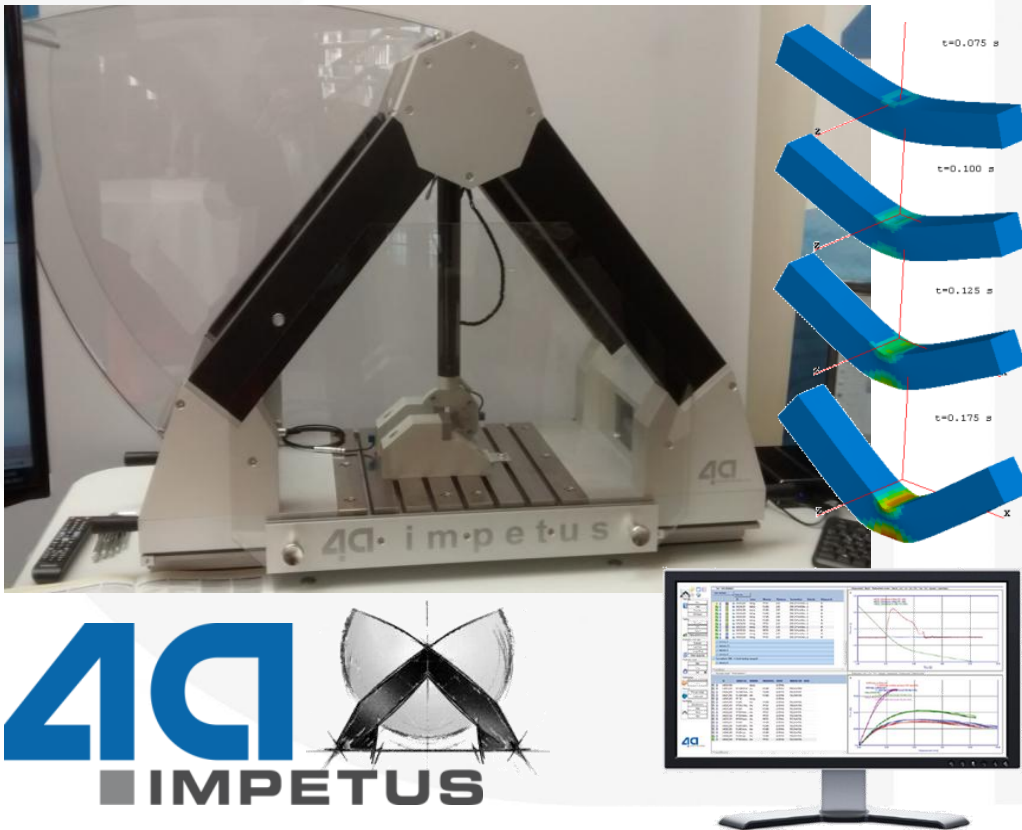

4a impetus – new hardware features

High-speed camera

- **Visualization of dynamic behavior** of the material during test (crack initiation and propagation)
- Easy view, different angles possible
- Trigger signal from 4a impetus
→ **synchronizing**

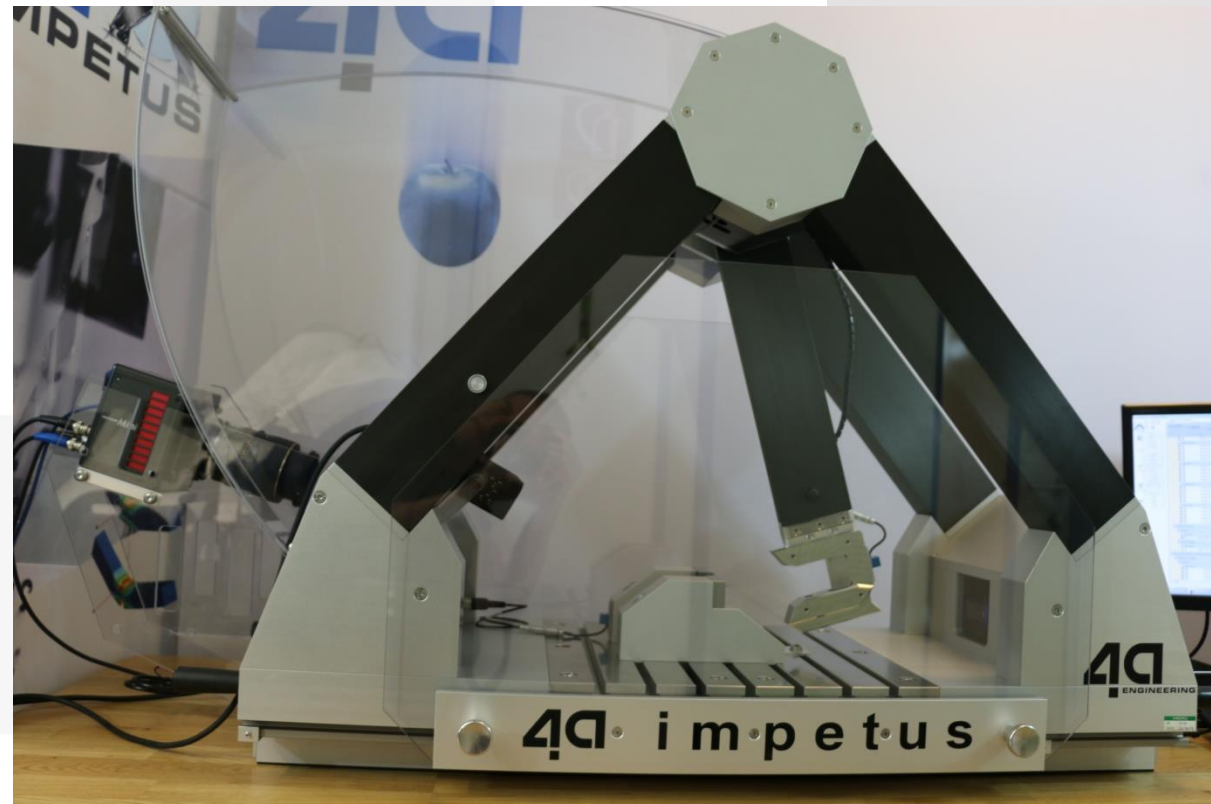

4a impetus

Software solution from the test to the material card

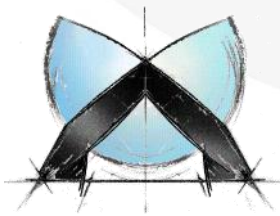
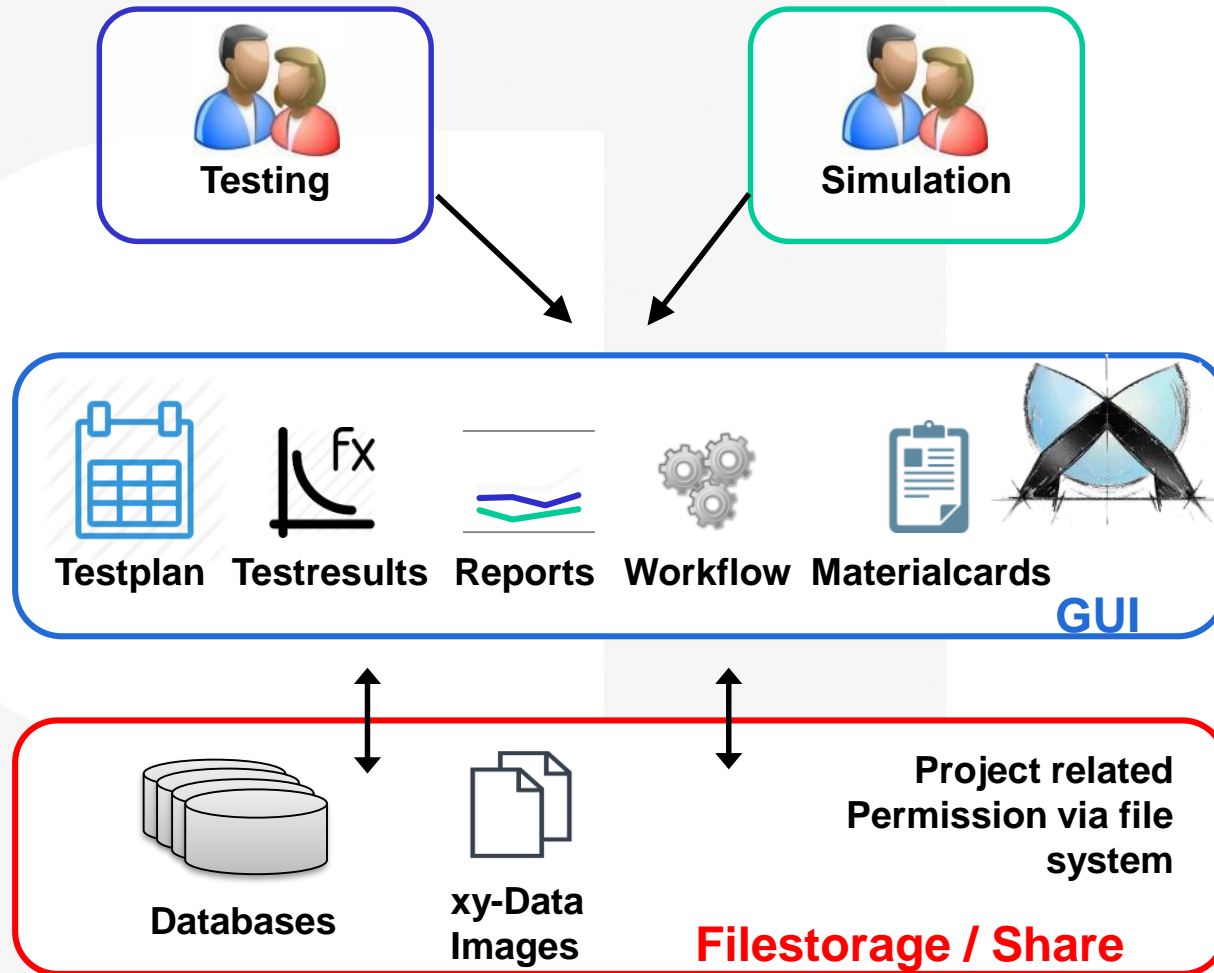

**4a impetus - intelligent testing systems
powered by 4a engineering GmbH**

4a Impetus v3.00 beta

licensed for Peter Reithofer 4aengineering

Versuch/Fest | Database Tests

Datum_Nr. 110125_001

Messung | Report | Messkurven | Viewer | a(t) | v(t) | s(t) | F(s) | E(t) | sig(eps) | epsplt(eps)

Allgemeine Informationen

Prüfsetup

Probekörper

Auswertung

Filter 0 kein Filter

Geschwindigkeitsermittl. 3 - Weg (statisch Anfangsanstieg)

Nulppunktsbestimmung 0 - manuelle (Zeitpunkt)

Brucherkennung 0 - manuell (Zeitpunkt)

Spannungsauswertung

Stoßigkeitiauswertung

Ergebnisse

Diagramm: Kraft [N] vs Weg [mm]

Diagramm: Externe Daten vs Externe Daten

Modelleinstellungen

Werkstoff

Materialklasse

Materialeigenschaft Thermoplast unv.

Materialverhalten

Materialeigenschaft benutzerdefiniert

Materialeigenschaft 339

Idealisierung

Einheitensystem SI(kg-m-sec-Pa)

Solver LS DYNA

Inputdeck customized

Modellsymmetrie Viertelmodell

Elementtyp Solid Hexaeder

Elementgröße 2

Kontaktstärke 0

Elementschichten 0

Benutzerdefinierter Parameter 0

001 nicht vorhanden

Aktive Datenbank: C:\DATEN\Projekte\11032201_hostaccm\main_v3.mdb

Complete system from the test to the validated material card

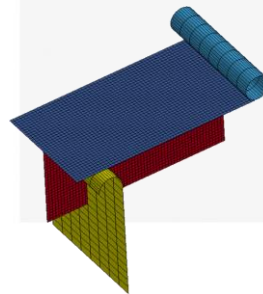
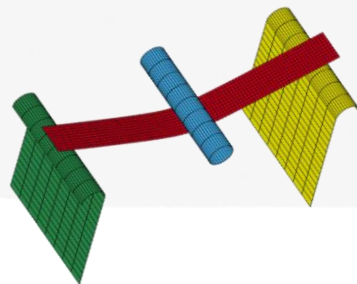
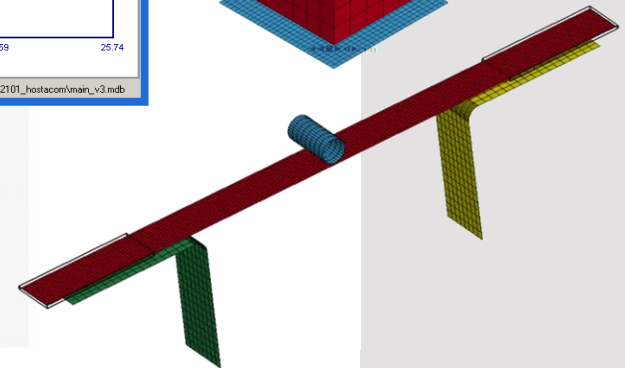
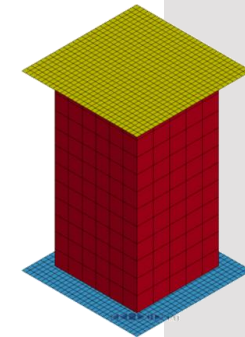

Short overview composites

- Unreinforced
- Particle reinforced ($l/d < 1$)
- Short fiber reinforced (l/d 20-40, $d \sim 10\mu\text{m}$)
- Long fiber reinforced (l/d 100-200, $d \sim 20\mu\text{m}$)
- Endless fiber reinforced ($l/d \gg 1000$)

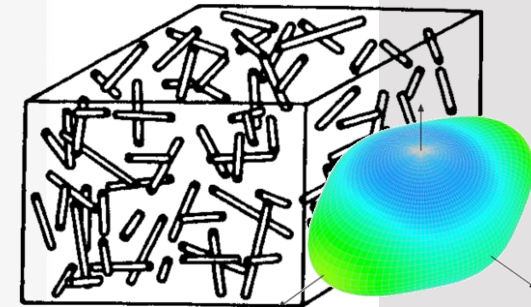

Short resp. long fiber

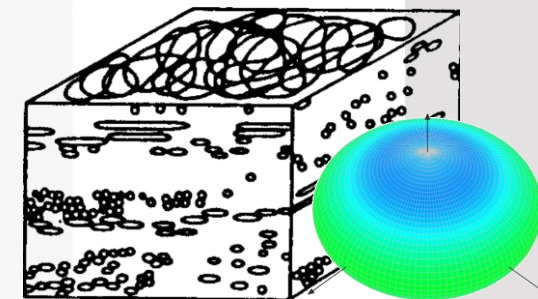

fiber mat

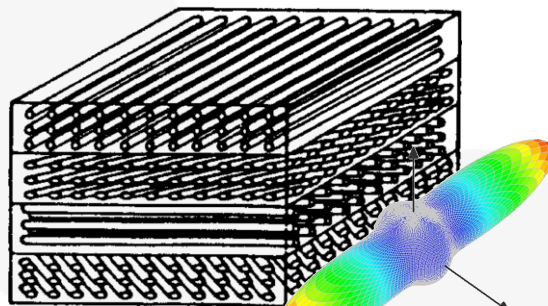

unidirectional
fiber layers

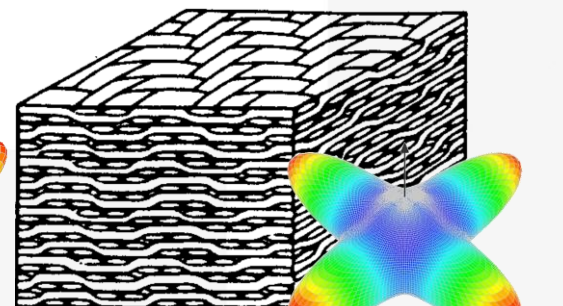

fabric

Source: Physik und Werkstoffkunde der Kunststoffe VO02/03, Montanuniversität Leoben

Overview composites

Material models in LS DYNA

No.	Elastic	Plastic	Damage	Strain rate	Failure	
2	Ortho / Anisotropic	None	None	None	*MAT_ADD_EROSION	SFRT / LFRT
24	Isotropic	Mises	None	Plasticity	*MAT_ADD_EROSION	
103	Isotropic	Hill	None	Plasticity	*MAT_ADD_EROSION	
108	Orthotropic	Hill	None	None	*MAT_ADD_EROSION	
157	Anisotropic	Hill	None	Plasticity	*MAT_ADD_EROSION	
215	*MAT_4a_micromec in development: Model based on MORI TANAKA MEANFIELD					
22	Orthotropic	None	None	None	Orientation dependent	Carbon, Glass, Kevlar endless & fabric
54/55	Orthotropic	None	Elastic Orthotropic	Strength	Chang-Chang/ Tsai-Wu Orientation dependent	
58	Orthotropic	None	Elastic Orthotropic	Strength, Stiffness	mod. Hashin Orientation dependent	
158	Orthotropic	None	Elastic Orthotropic	Visco-elasticity	Orientation dependent	
261	Orthotropic	None	Elastic Orthotropic	None	failure Pinho (Puck) Orientation dependent	
262	Orthotropic	None	Elastic Orthotropic	None	failure Camanho (Puck) Orientation dependent	

Short and long fiber reinforced thermoplastics

No.	Elastic	Plastic	Damage	Strain rate	Failure	
2	Ortho / Anisotropic	None	None	None	*MAT_ADD_EROSION	SFRT/LFRT
24	Isotropic	Mises	None	Plasticity	*MAT_ADD_EROSION	
103	Isotropic	Hill	None	Plasticity	*MAT_ADD_EROSION	
108	Orthotropic	Hill	None	None	*MAT_ADD_EROSION	
157	Anisotropic	Hill	None	Plasticity	*MAT_ADD_EROSION	
215	*MAT_4a_micromec in development: Model based on MORI TANAKA MEANFIELD					

Short and long fiber reinforced thermoplastics

Typical applications and materials

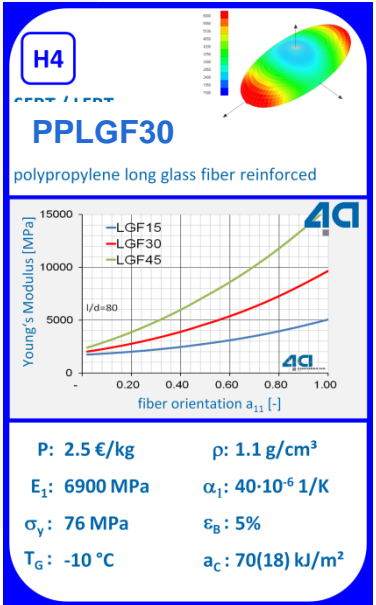
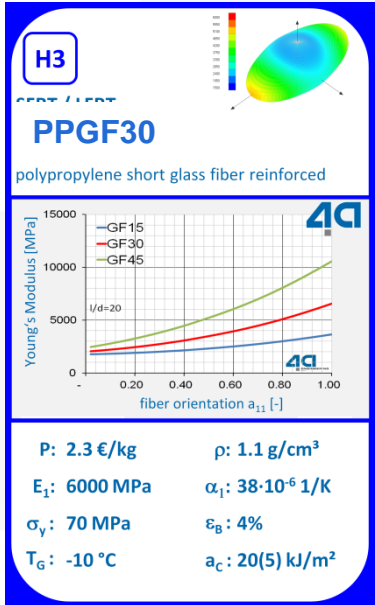
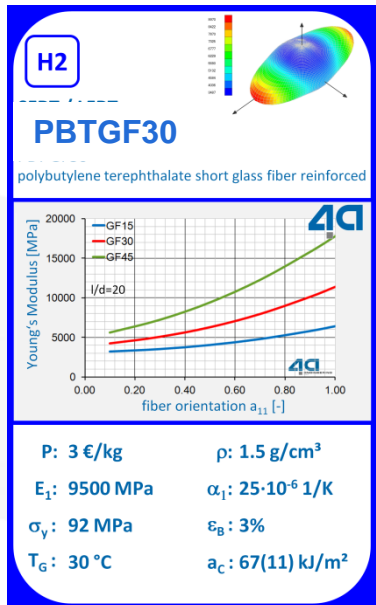
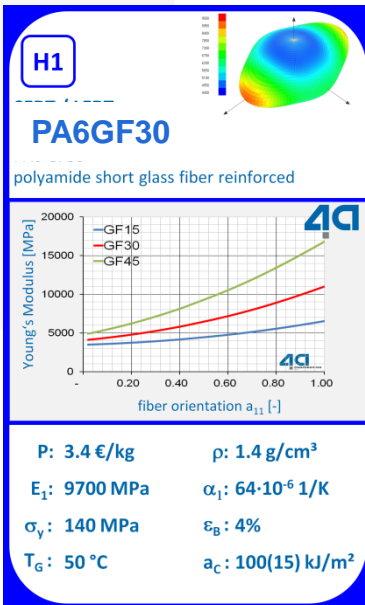
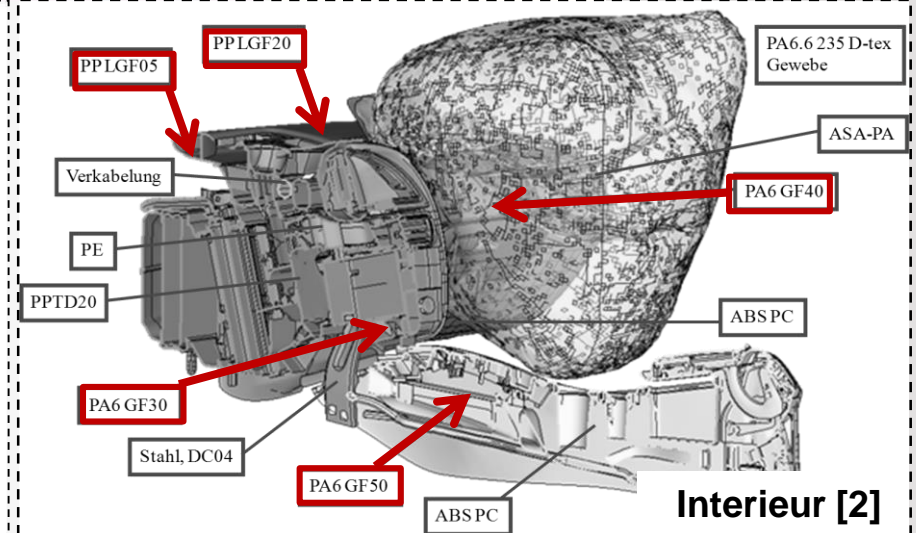
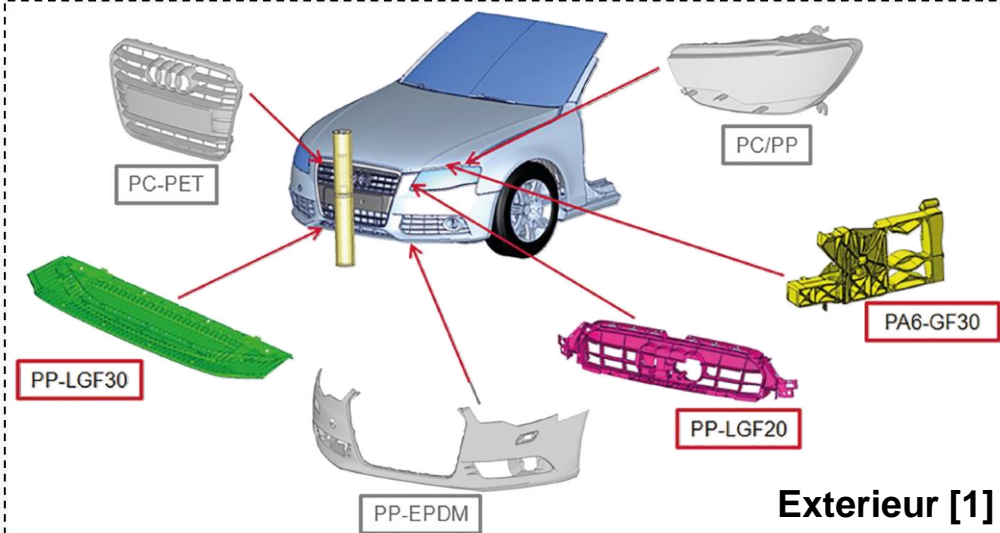

[1] A. Koukal, Audi AG - *Crash- und Bruchverhalten von Kunststoffen im Fußgängerschutz von Fahrzeugen*, TU München, 2014

[2] R. Luijckx, Audi AG - *Kunststoffmaterialien in der Interieur Funktionsauslegung bei Audi AG*, 4a Technologietag 2010

Short and long fiber reinforced thermoplastics

Typical material behavior

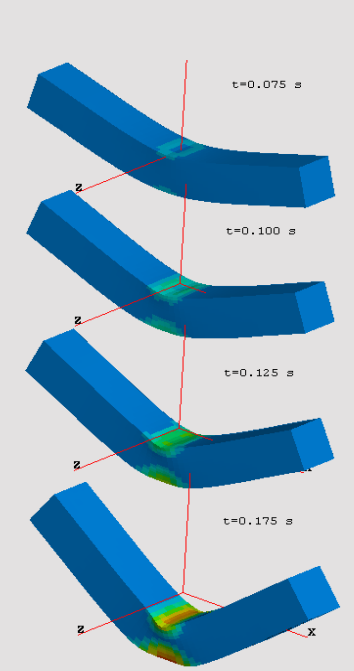
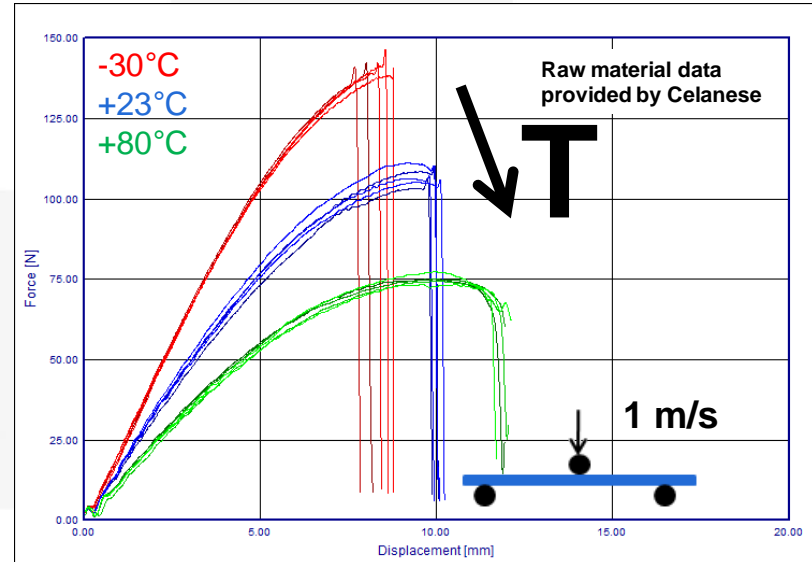
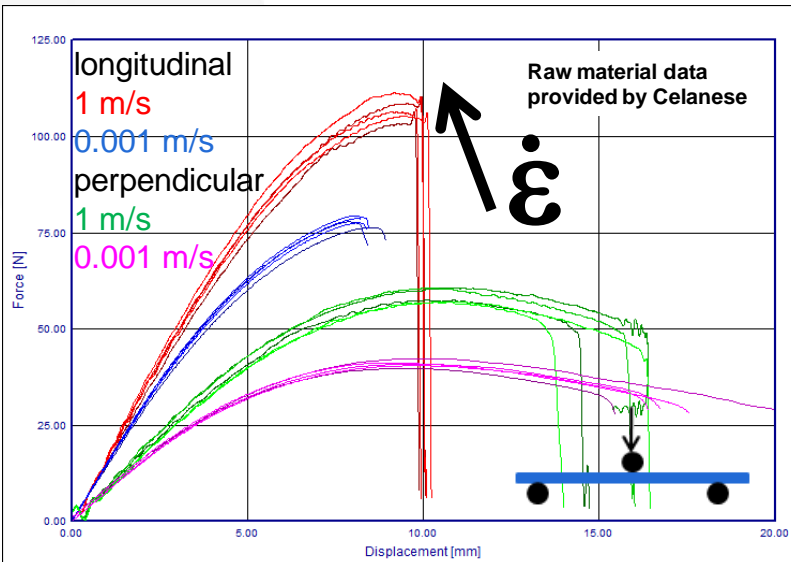
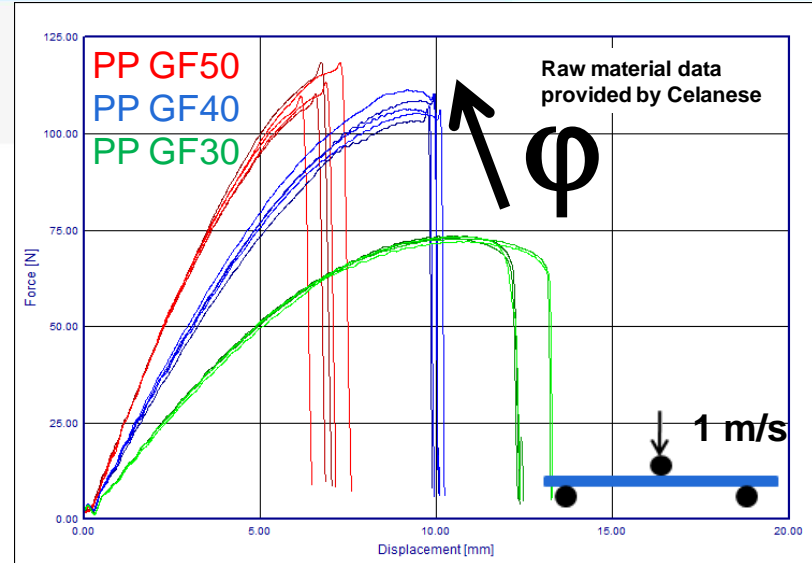
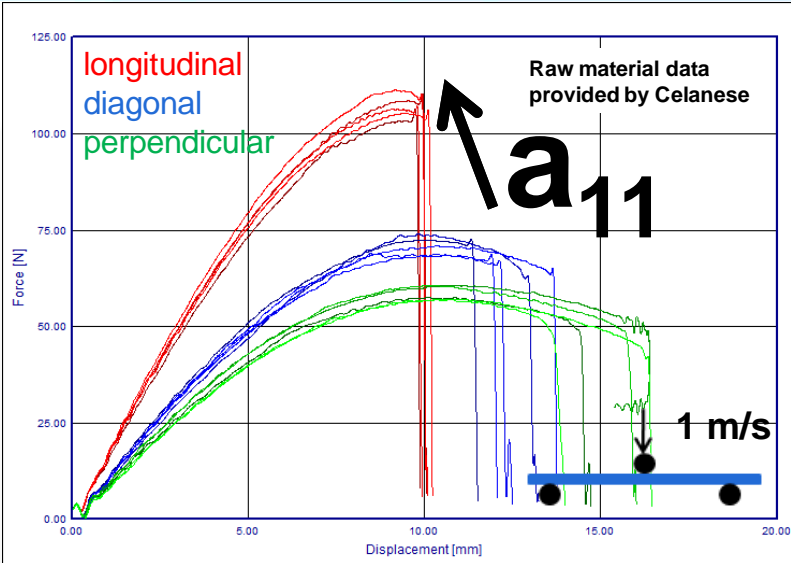

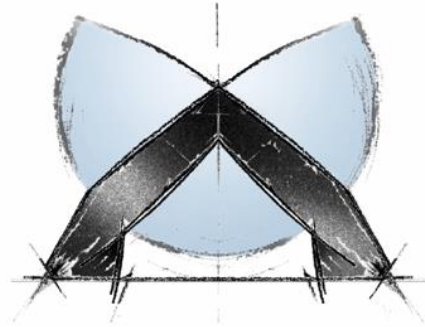

4a
■ IMPETUS

ADVANCED

dynamic testing system
validated material cards
intelligent software solution

I N P H Y I S I C S W E T R U S T

Video: www.youtube/

Short and long fiber reinforced thermoplastics

No.	Elastic	Plastic	Damage	Strain rate	Failure	
2	Ortho / Anisotropic	None	None	None	*MAT_ADD_EROSION	SFRT/LFRT
24	Isotropic	Mises	State of the art (Quick&Dirty)			
103	Isotropic	Hill	None	Plasticity	*MAT_ADD_EROSION	
108	Orthotropic	Hill	None	None	*MAT_ADD_EROSION	
157	Anisotropic	Hill	Composite (LSDYNA R9)			
215	*MAT_4a_micromec in development: Model based on MORI TANAKA				(LSDYNA R10)	

Short and long fiber reinforced thermoplastics

4a impetus *MAT_024 – PP-GF40 diagonal, 23°C

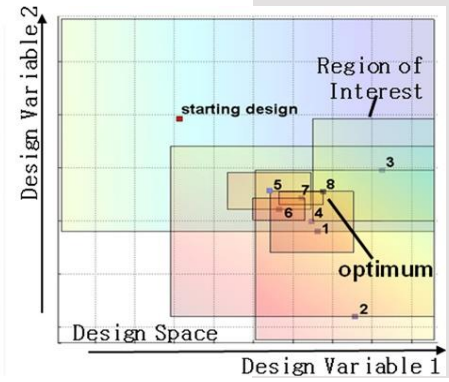
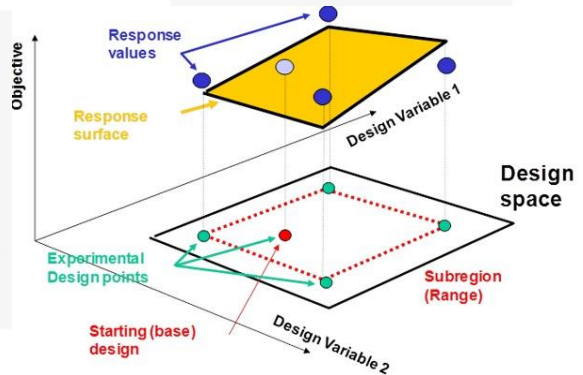
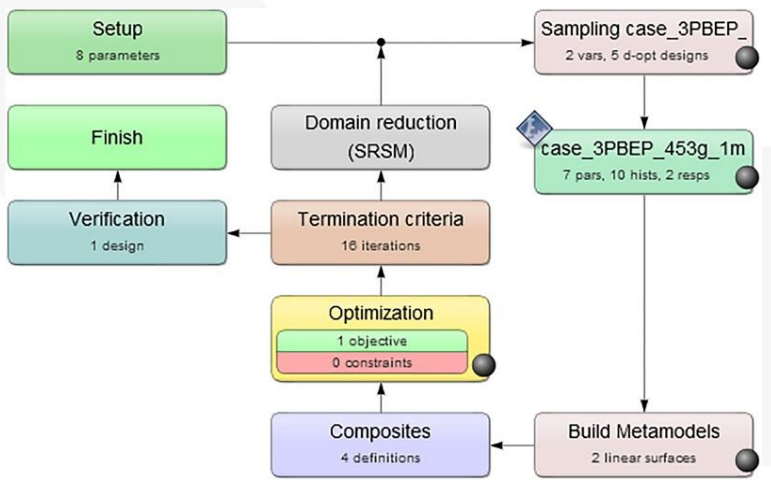
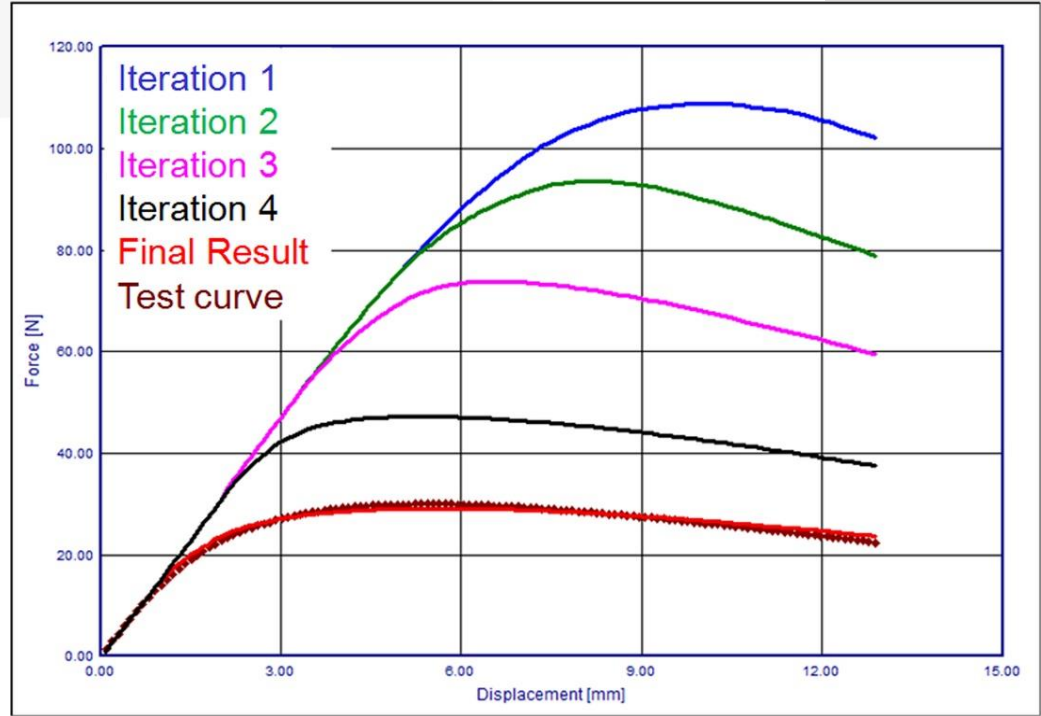
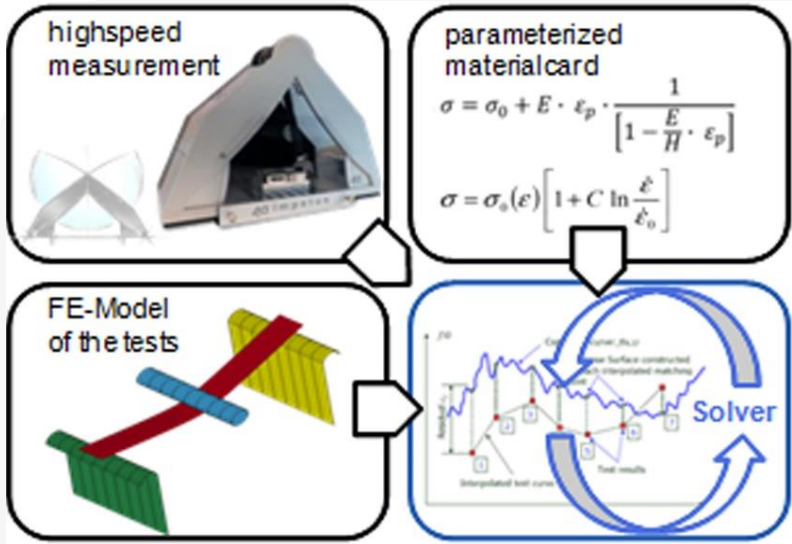

Source: Dynamic Material Characterization Using 4a impetus – PPS Conference 2015, Graz

© 4a engineering GmbH, all rights reserved

Short and long fiber reinforced thermoplastics

4a impetus *MAT_024 – PP-GF40 diagonal, 23°C

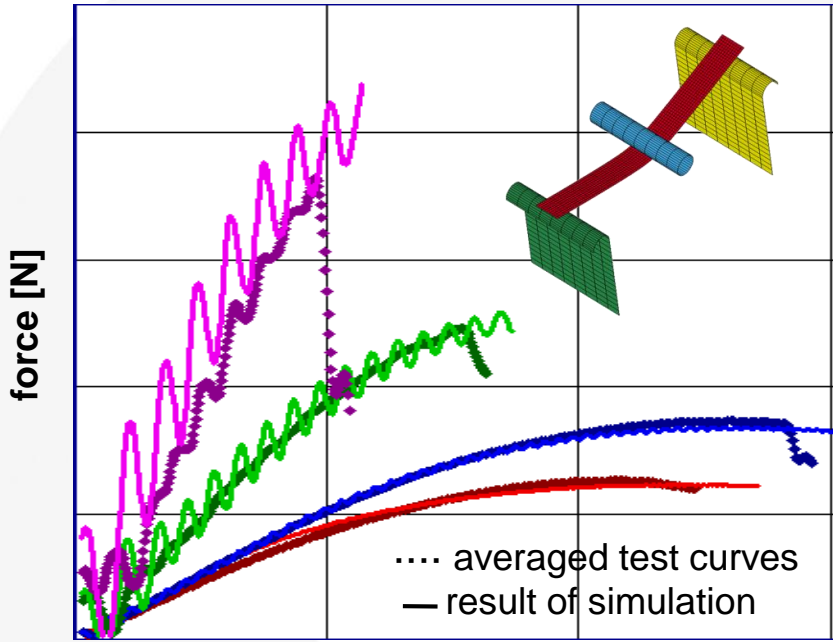

displacement [mm]

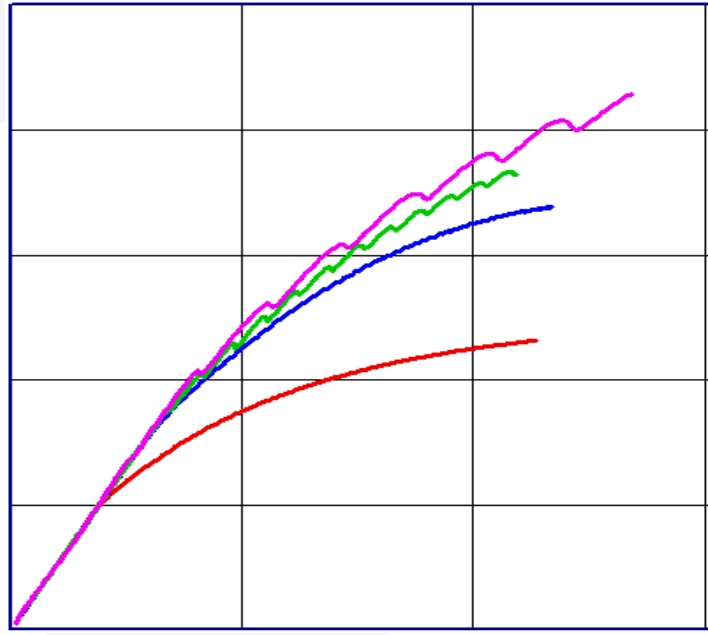

strain [-]

V [m/s]	S [mm]
0.001	50
1	50
2.5	40
4.3	30

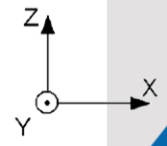
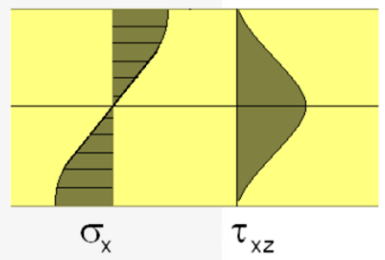
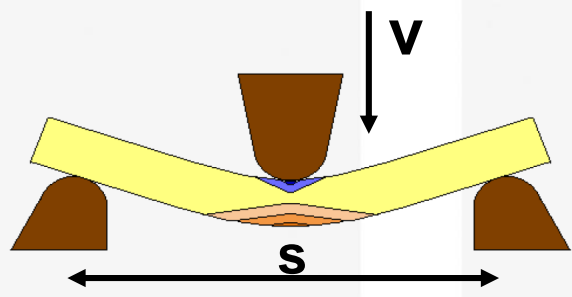

Source: M.Fritz - Ermittlung von Werkstoffparametern für die Fahrzeug-Crashsimulation aus Biegeversuchen, Diploma thesis, Montanuniversität Leoben

© 4a engineering GmbH, all rights reserved

Short and long fiber reinforced thermoplastics

Actual approaches

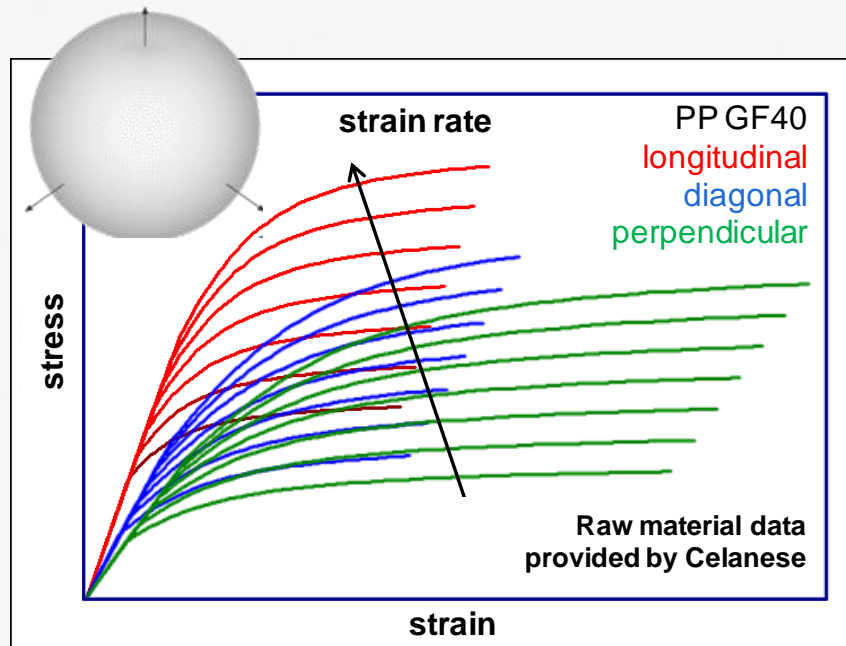

- quick&dirty isotropic material card (CAMPUS / average / worst case)
- critical loading transversal to fiber orientation

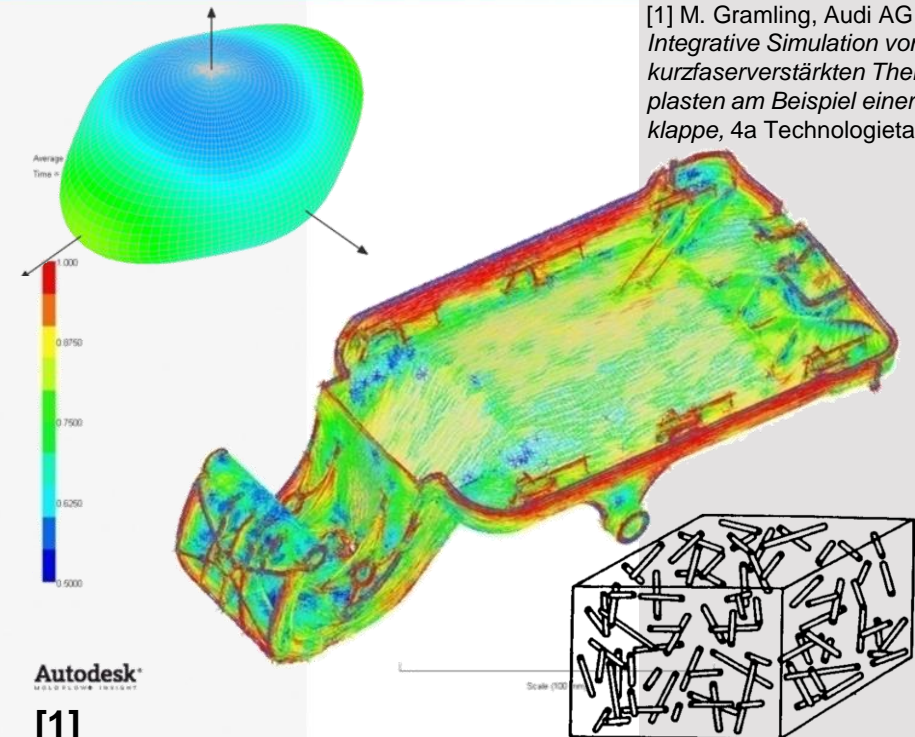

[1] M. Gramling, Audi AG - Integrative Simulation von kurzfaserverstärkten Thermoplasten am Beispiel einer Tankklappe, 4a Technologietag 2012

- micro mechanic modelling (mean field homogenization / RVE)
- high costs (CPU time)
- no standard (understanding)

Short and long fiber reinforced thermoplastics

No.	Elastic	Plastic	Damage	Strain rate	Failure	
2	Ortho / Anisotropic	None	None	None	*MAT_ADD_EROSION	SFRT/LFRT
24	Isotropic	Mises	None	Plasticity	*MAT_ADD_EROSION	
103	Isotropic	Hill	None	Plasticity	*MAT_ADD_EROSION	
108	Orthotropic	Hill	None	None	*MAT_ADD_EROSION	
157	Anisotropic	Hill	Composite (LSDYNA R9)			
215	*MAT_4a_micromec in development: Model based on MORI TANAKA				(LSDYNA R10)	

Short and long fiber reinforced thermoplastics

Fiber orientation

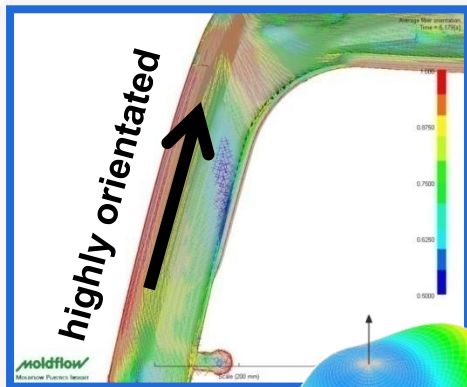

$$a_{ij} = \begin{bmatrix} 0,87 & 0 & 0 \\ 0 & 0,11 & 0 \\ 0 & 0 & 0,02 \end{bmatrix}$$

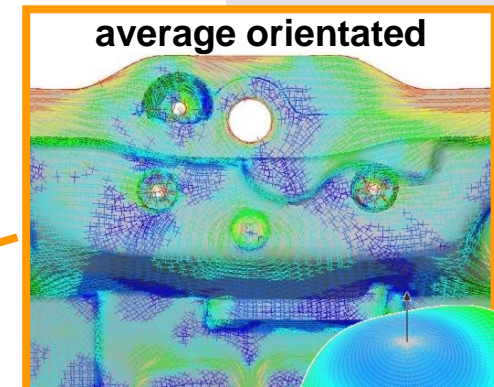
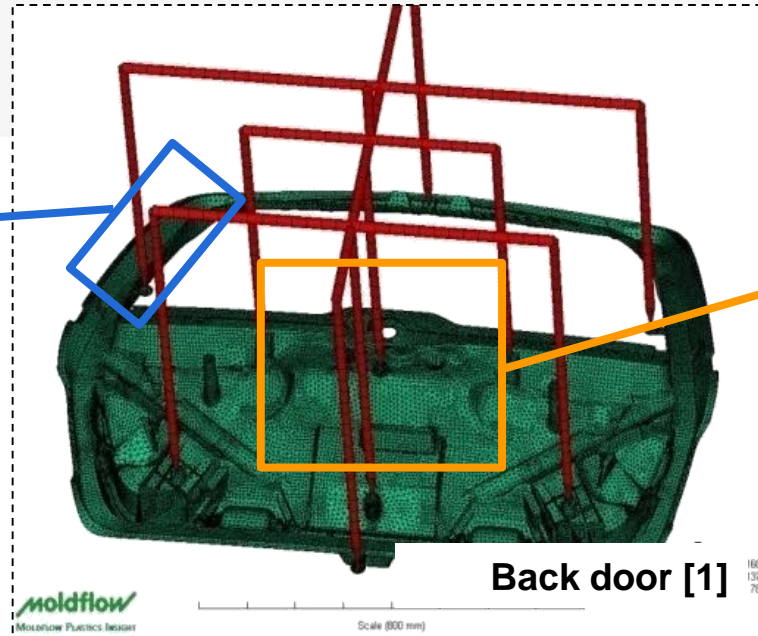

$$a_{ij} = \begin{bmatrix} 0,66 & 0 & 0 \\ 0 & 0,32 & 0 \\ 0 & 0 & 0,02 \end{bmatrix}$$

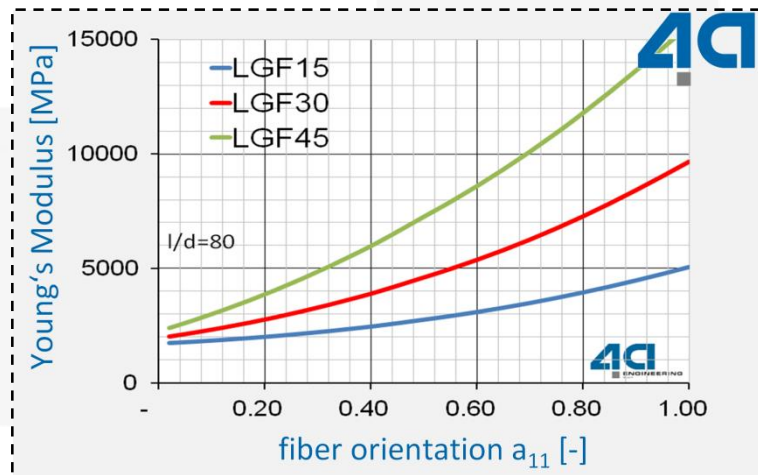

[1] P. Reithofer - *Integrative Simulation – Berücksichtigung der prozessbedingten Anisotropie*, 4a Technologietag 2011

Short and long fiber reinforced thermoplastics

Simulation process chain

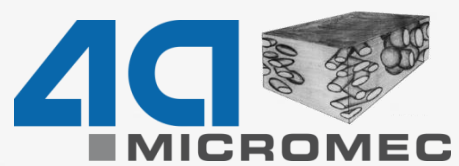
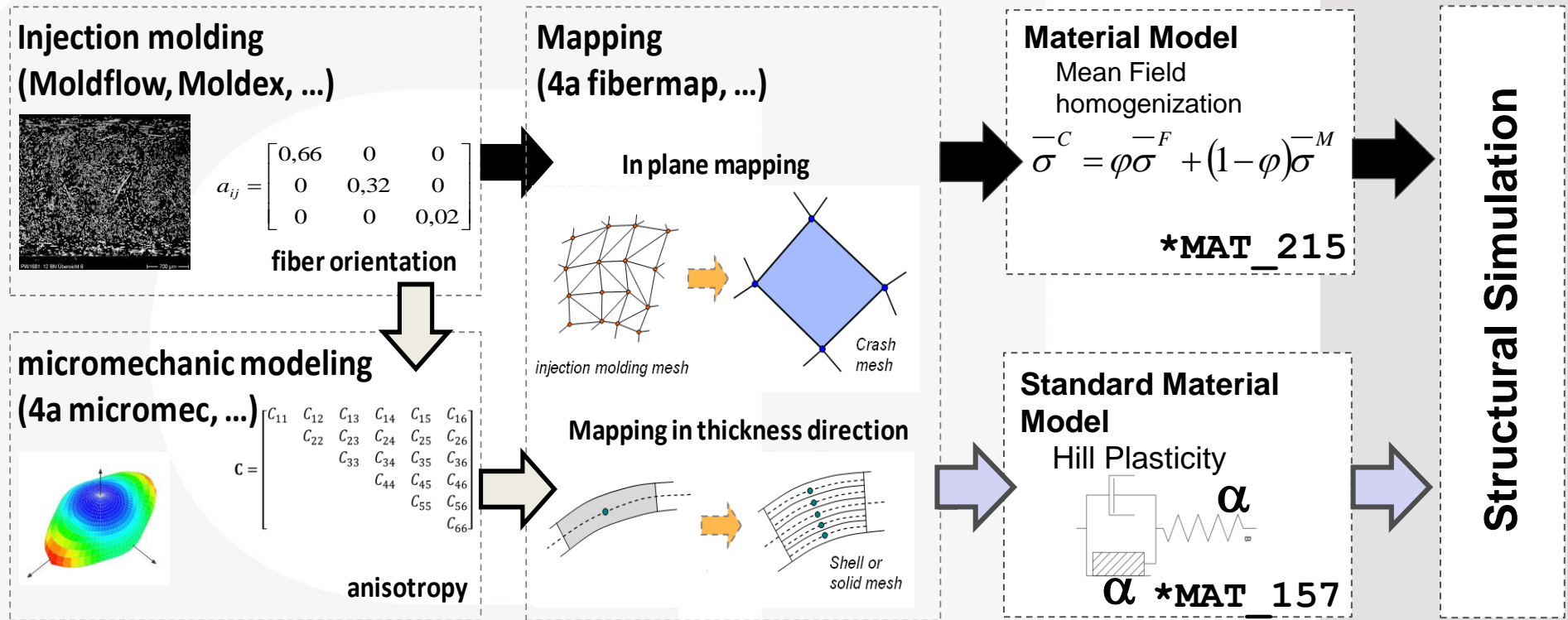

- Hill plasticity → „extended“ von Mises

$$\sigma_{eq} = \sqrt{F(\sigma_{22} - \sigma_{33})^2 + G(\sigma_{33} - \sigma_{11})^2 + H(\sigma_{11} - \sigma_{22})^2 + 2L\sigma_{23}^2 + 2M\sigma_{31}^2 + 2N\sigma_{12}^2}$$

$$F = \frac{(\sigma^0)^2}{2} \left(\frac{1}{\bar{\sigma}_{22}^2} + \frac{1}{\bar{\sigma}_{33}^2} - \frac{1}{\bar{\sigma}_{11}^2} \right) = \frac{1}{2} \left(\frac{1}{R_{22}^2} + \frac{1}{R_{33}^2} - \frac{1}{R_{11}^2} \right), \quad L = \frac{3}{2} \left(\frac{\tau^0}{\bar{\sigma}_{23}} \right)^2 = \frac{3}{2R_{23}^2},$$

$$G = \frac{(\sigma^0)^2}{2} \left(\frac{1}{\bar{\sigma}_{33}^2} + \frac{1}{\bar{\sigma}_{11}^2} - \frac{1}{\bar{\sigma}_{22}^2} \right) = \frac{1}{2} \left(\frac{1}{R_{33}^2} + \frac{1}{R_{11}^2} - \frac{1}{R_{22}^2} \right), \quad M = \frac{3}{2} \left(\frac{\tau^0}{\bar{\sigma}_{13}} \right)^2 = \frac{3}{2R_{13}^2},$$

$$H = \frac{(\sigma^0)^2}{2} \left(\frac{1}{\bar{\sigma}_{11}^2} + \frac{1}{\bar{\sigma}_{22}^2} - \frac{1}{\bar{\sigma}_{33}^2} \right) = \frac{1}{2} \left(\frac{1}{R_{11}^2} + \frac{1}{R_{22}^2} - \frac{1}{R_{33}^2} \right), \quad N = \frac{3}{2} \left(\frac{\tau^0}{\bar{\sigma}_{12}} \right)^2 = \frac{3}{2R_{12}^2},$$

- Material model based on **composites properties**

description	variables	Number of variables	dependencies
anisotropic stiffness	Cij	21	$C_{ij}(a_{ij}, \varphi, C^M, C^F)$
Hill plasticity	3D: F, G, H, L, M, N 2D: r00, r45, r90	6	$f(a_{ij}, \varphi, \sigma^M, \sigma^F)$
stress-strain curve	Loadcurve	3	$f(a_{ij}, \varphi)$
failure	Loadcurve	6	$f(a_{ij}, \varphi)$

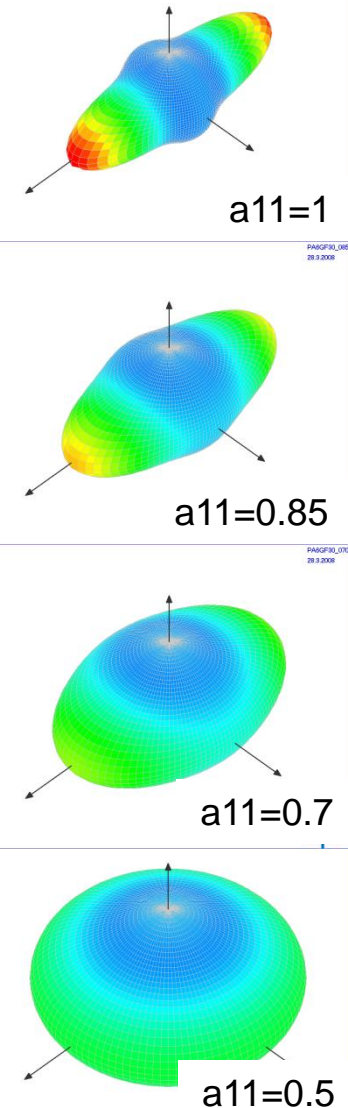

- Not possible to generate samples with **explicit defined and varying a_{ij}**
- Hard to characterize, too many possibilities in a_{ij}

→ **Micro mechanical model is needed**

„key enabler“ - micromechanics

No.	Elastic	Plastic	Damage	Strain rate	Failure	
2	Ortho / Anisotropic	None	None	None	*MAT_ADD_EROSION	SFRT/LFRT
24	Isotropic	Mises	None	Plasticity	*MAT_ADD_EROSION	
103	Isotropic	Hill	None	Plasticity	*MAT_ADD_EROSION	
108	Orthotropic	Hill	None	None	*MAT_ADD_EROSION	
157	Anisotropic	Hill	Composite (LSDYNA R9)			
215	*MAT_4a_micromec in development: Model based on MORI TANAKA MEANFIELD					

Micromechanical approach

Mean field homogenization

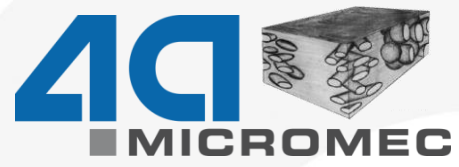

Standalone product

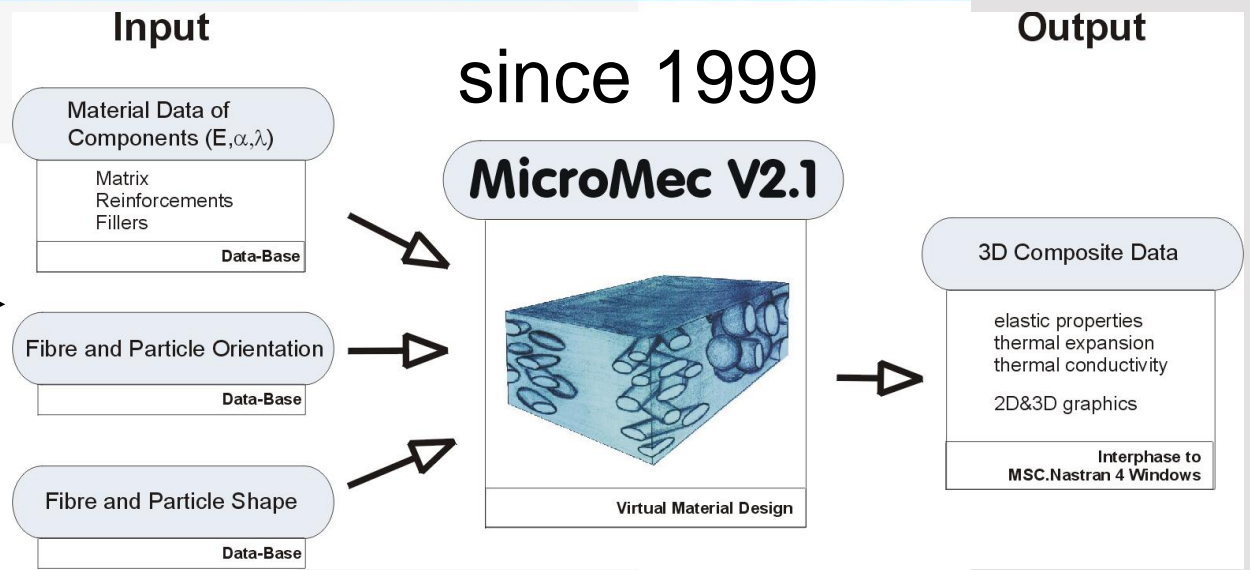

$$\bar{\sigma}^C = \phi \bar{\sigma}^F + (1 - \phi) \bar{\sigma}^M$$

C...composite, F...fiber, M...matrix

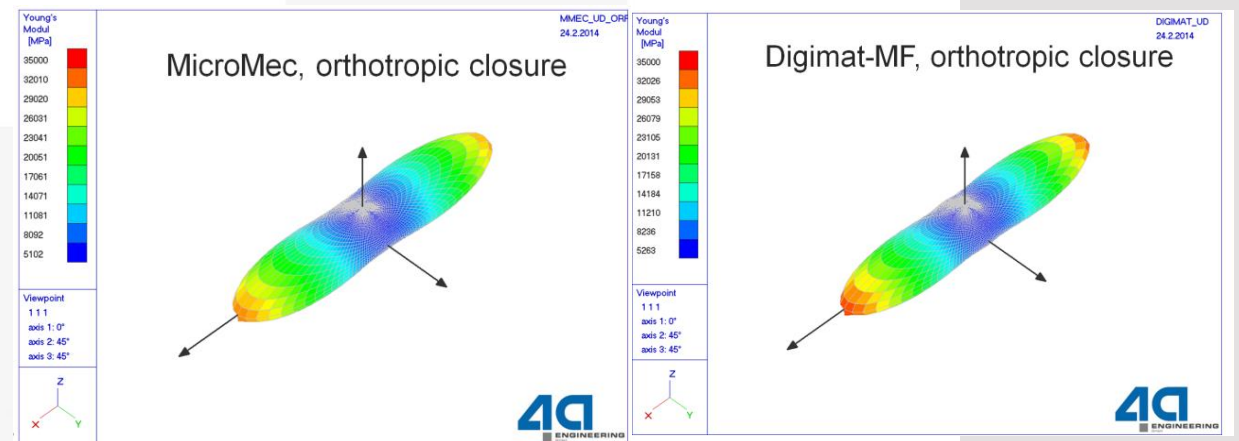

[1]

[1] Ch. Bodor - Kopplung μ CT und FEM Berechnung, 4a Technologietag 2014

Comparison by University of Leoben

Micromechanical approach

Mean field homogenization



Standalone product

Library



*MAT_157

calculate parameter for constitutive law

$$\bar{\sigma}^C = \varphi \bar{\sigma}^F + (1 - \varphi) \bar{\sigma}^M$$

C...composite, F...fiber, M...matrix

160223_006		Material	Designvariablen	Layers
[-] Strain rate dependency	Table			
[-] Strain rate dependency	Johnson Cook			
[-] Micromec	User defined			
[-] Matrix				
Density of the matrix	900			
E-Modulus	1500			
Poisson's ratio	0.3			
Yield strength	15			
Strength at Break	17			
Failure strain	0.05			
[-] Fiber				
Fillerlength	1000			
Fillerdiameter	20			
Phi or Psi	φ			
Phi	12.9			
Psi	30.1			
Fillermaterial	E-Glas			
[-] Orientation				
[-] Fillerorientationtype	CA lin. OF			
Fillerorientationvalue 1	0.6			
Fillerorientationvalue 2	0.33			
Composite Density	1126	[g/dm³]		
c_C11	6172	[MPa]		
c_C12	1808	[MPa]		
c_C13	1231	[MPa]		
c_C14	0	[MPa]		
c_C15	0	[MPa]		
c_C16	0	[MPa]		
c_C22	4135	[MPa]		
c_C23	1181	[MPa]		
c_C24	0	[MPa]		
c_C25	0	[MPa]		
c_C26	0	[MPa]		
c_C33	2616	[MPa]		
c_C34	0	[MPa]		
c_C35	0	[MPa]		
c_C36	0	[MPa]		
c_C44	1554	[MPa]		
c_C45	0	[MPa]		
c_C46	0	[MPa]		
c_C55	888.6	[MPa]		
c_C56	0	[MPa]		
c_C66	957.5	[MPa]		
y_r00	1	[1]		
y_r45	0.5105	[1]		
y_r90	0.2665	[1]		
y_scalematrix0	3.076	[1]		

matrix

filler

orientation

Micromechanical approach

4a impetus – example *MAT_157

Name	Start	const...	Description
Group: 10_elasticity			
c_C11	MMEC	<input checked="" type="checkbox"/>	constitutive matrix 11
c_C12	MMEC	<input checked="" type="checkbox"/>	constitutive matrix 12
c_C13	MMEC	<input checked="" type="checkbox"/>	constitutive matrix 13
c_C14	MMEC	<input checked="" type="checkbox"/>	constitutive matrix 14
c_C15	MMEC	<input checked="" type="checkbox"/>	constitutive matrix 15
c_C16	MMEC	<input checked="" type="checkbox"/>	constitutive matrix 16
c_C22	MMEC	<input checked="" type="checkbox"/>	constitutive matrix 23
c_C23	MMEC	<input checked="" type="checkbox"/>	constitutive matrix 23
c_C24	MMEC	<input checked="" type="checkbox"/>	constitutive matrix 24
c_C25	MMEC	<input checked="" type="checkbox"/>	constitutive matrix 25
c_C26	MMEC	<input checked="" type="checkbox"/>	constitutive matrix 26
c_C33	MMEC	<input checked="" type="checkbox"/>	constitutive matrix 33
c_C34	MMEC	<input checked="" type="checkbox"/>	constitutive matrix 34
c_C35	MMEC	<input checked="" type="checkbox"/>	constitutive matrix 35
c_C36	MMEC	<input checked="" type="checkbox"/>	constitutive matrix 36
c_C44	MMEC	<input checked="" type="checkbox"/>	constitutive matrix 44
c_C45	MMEC	<input checked="" type="checkbox"/>	constitutive matrix 45
c_C46	MMEC	<input checked="" type="checkbox"/>	constitutive matrix 46
c_C55	MMEC	<input checked="" type="checkbox"/>	constitutive matrix 55
c_C56	MMEC	<input checked="" type="checkbox"/>	constitutive matrix 56
c_C66	MMEC	<input checked="" type="checkbox"/>	constitutive matrix 66

Name	Start	const...	Description
Group: 20_yield			
y_0	90	<input type="checkbox"/>	yield stress
y_scale...	MMEC	<input checked="" type="checkbox"/>	yield scale 11 direction
y_r00	MMEC	<input checked="" type="checkbox"/>	yield hill anisotropy ratio 0°
y_r45	MMEC	<input checked="" type="checkbox"/>	yield hill anisotropy ratio 45°
y_r90	MMEC	<input checked="" type="checkbox"/>	yield hill anisotropy ratio 90°
Group: 21_hardening			
h_ET	50	<input type="checkbox"/>	
h_y	90	<input checked="" type="checkbox"/>	
Group: 31_strainrate			
v_epspkt	0.01	<input checked="" type="checkbox"/>	initial strain rate threshold
v_p	15	<input type="checkbox"/>	strain rate scale (1/vp)
Group: 51_failure			
xf_NUM...	0.75	<input checked="" type="checkbox"/>	Number of failed integration points prior to

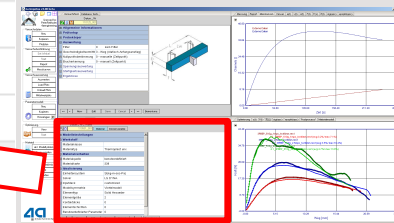
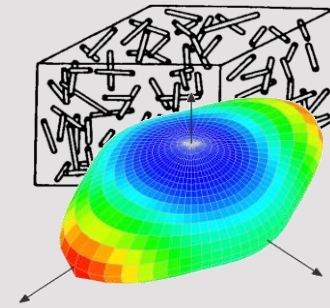

e.g.: 30 design variables for
*MAT_157

MMEC – design variable calculated by micro mechanic model
Less free design variables left for material parameter identification

Micromechanical approach

4a impetus – example *MAT_157

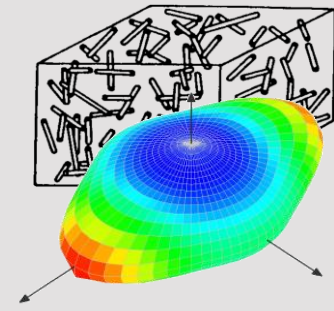
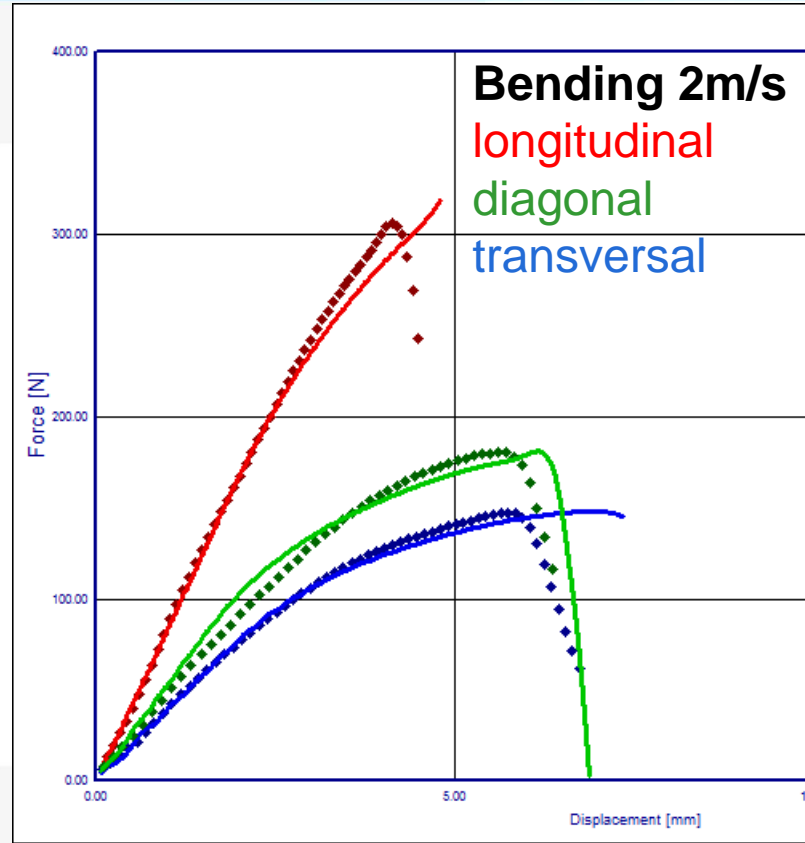
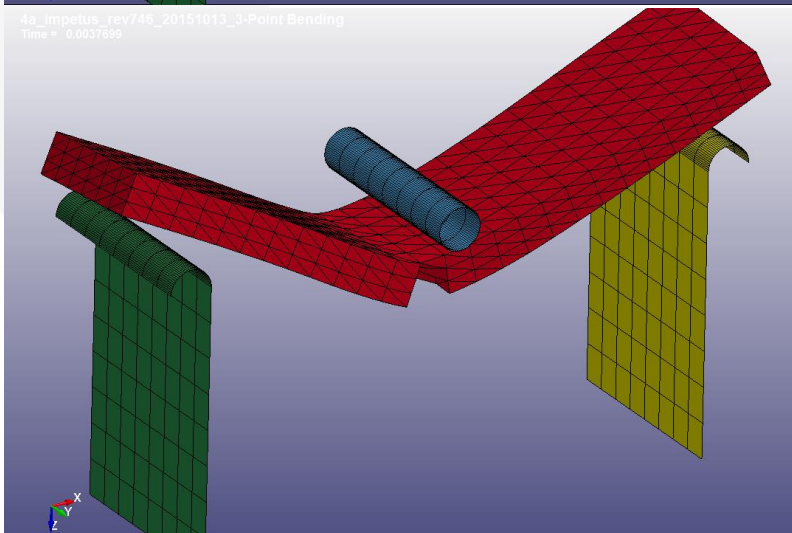
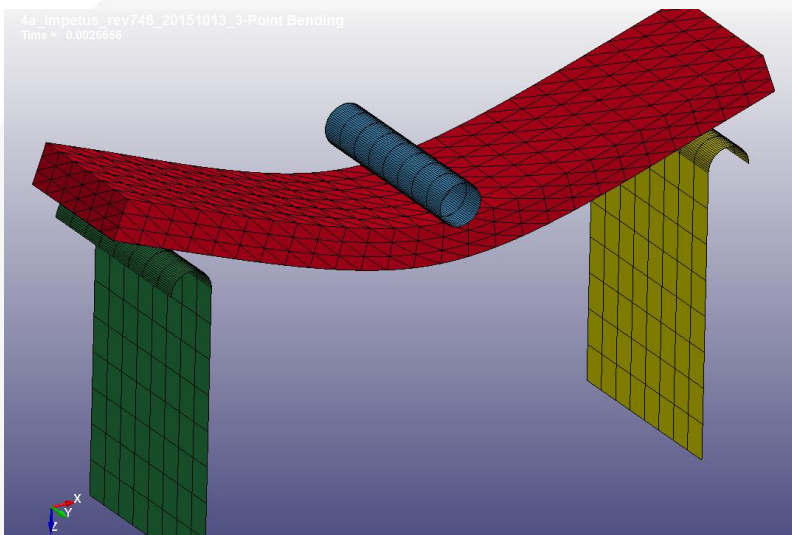

[P. Reithofer et al - Material characterization of composites using micro mechanic models as key enabler, CAE Grand Challenge 2016, Hanau]

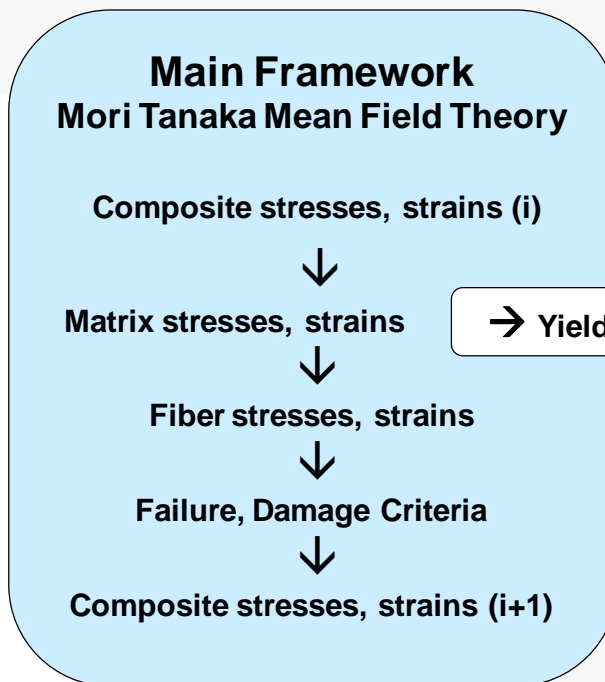
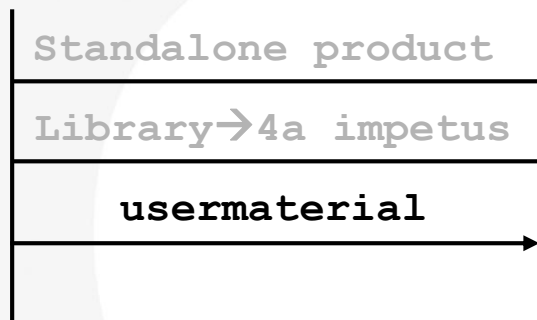

plug able
possible extensions
other plasticity
formulations,

→ Yield condition

→ J2 Plasticity
Isotropic Hardening

Table Lookup or
Parameter Setup

$$\bar{\sigma}^C = \varphi \bar{\sigma}^F + (1 - \varphi) \bar{\sigma}^M$$

C...composite, F...fiber, M...matrix

assumption elliptical inclusion
(Eshelby Tensor)

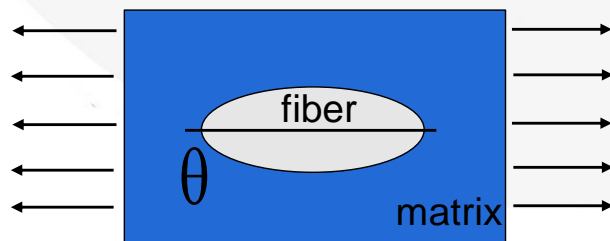

$$\Delta \varepsilon^C \Rightarrow \Delta \varepsilon^M, (\Delta \varepsilon^F)$$

$$\Delta \varepsilon^M = \frac{1}{\varphi \bar{B}_i + (1 - \varphi) I} \Delta \varepsilon^C$$

$$\Delta \varepsilon^M \Rightarrow E_M^T, \Delta \varepsilon_{pl}^M, \Delta \sigma^M$$

$$\bar{B}_{i+1} = f(f_0^{(4)}, E_M^T, l/d)$$

$$\bar{A} = S^F \bar{B}_{i+1} C^M$$

$$\Delta \sigma^C = [\varphi \bar{A} + (1 - \varphi) I] \Delta \sigma^M$$

Micromechanical approach

Mean field homogenization



Standalone product
 Library → 4a impetus
 usermaterial
***MAT_4A_MICROMECH**



SFRT / LFRT

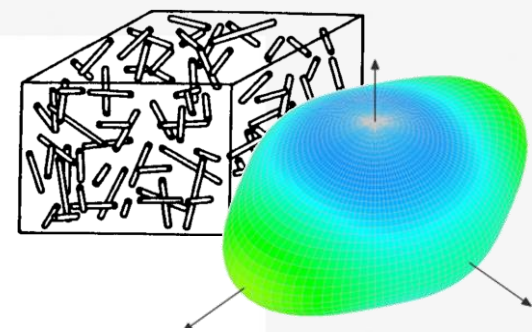

***MAT_215**
 matrix:
 ■ isotropic elastic
 viscoplastic (like MAT_024)
 fiber:
 ■ isotropic elastic

INITIAL_STRESS

Composite

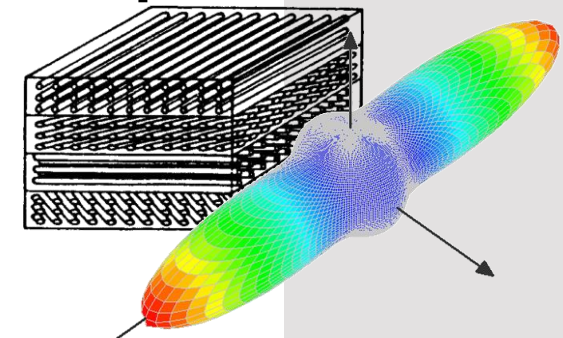

***MAT_215**
 matrix:
 ■ isotropic elastic
 fiber:
 ■ transversal isotropic elastic

COMPOSITE (PLY)

*MAT_215 / *MAT_4A_MICROMECH

No.	Elastic	Plastic	Damage	Strain rate	Failure	
2	Ortho / Anisotropic	None	None	None	*MAT_ADD_EROSION	SFRT/LFRT
24	Isotropic	Mises	None	Plasticity	*MAT_ADD_EROSION	
103	Isotropic	Hill	None	Plasticity	*MAT_ADD_EROSION	
108	Orthotropic	Hill	None	None	*MAT_ADD_EROSION	
157	Anisotropic	Hill	None	Plasticity	*MAT_ADD_EROSION	
215	*MAT_4a_micromec in development: Model based on MORI TANAKA				(LSDYNA R10)	

Keyword format

CARD 1: General Options / Parameter

CARD 2-3: Element orientation*

analog to LSDYNA standard anisotropic material cards

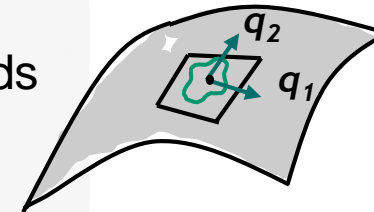

CARD 4: Composite Buildup*

Card 4	1	2	3	4	5	6	7	8
	FVF		FL	FD		A11	A22	
PP GF30	-0.3		200.0	10.0		0.7	0.25	
PP LGF50	-0.5		1000.0	20.0		0.65	0.30	
PA6 GF45	-0.45		250.0	10.0		0.8	0.15	
Carbon UD	0.6		10000.0	10.0		1.0	0.0	

FVF > 0: fiber volume fraction → Composite
 FVF < 0: fiber mass fraction → SFRT/LFRT

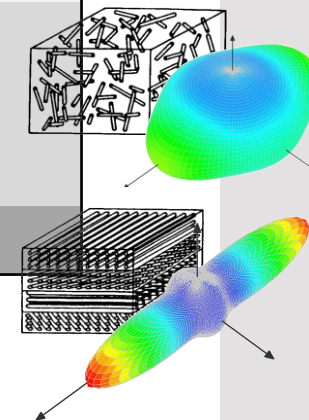

*may be overwritten by

*INITIAL_STRESS_SHELL/SOLID

exemplary values without any warranty

Keyword format

CARD 5: fiber material

Standard values from literature

Card 5	1	2	3	4	5	6	7	8
FIBER	ROF	EL	ET	GLT	PRTL	PRTT		
UNITS	kg/mm ³	GPa	GPa	GPa	-	-		
glass	2.59E-6	70.0	70.0	28.8	0.217	0.217		
T400	1.76E-6	218.8	28.0	50.0	0.02943	0.390		

glass fiber (isotropic)

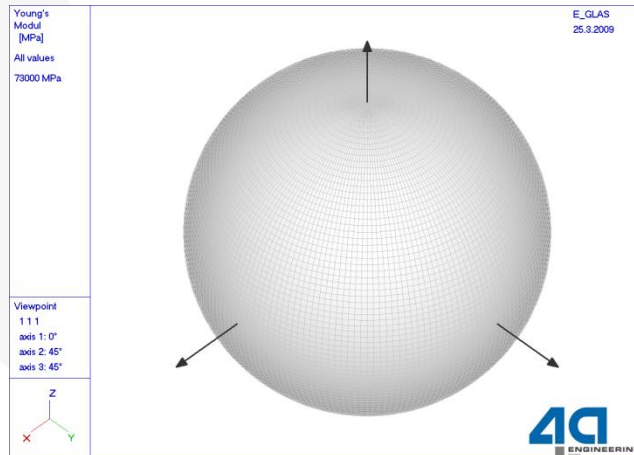

T400 (transversal isotropic)

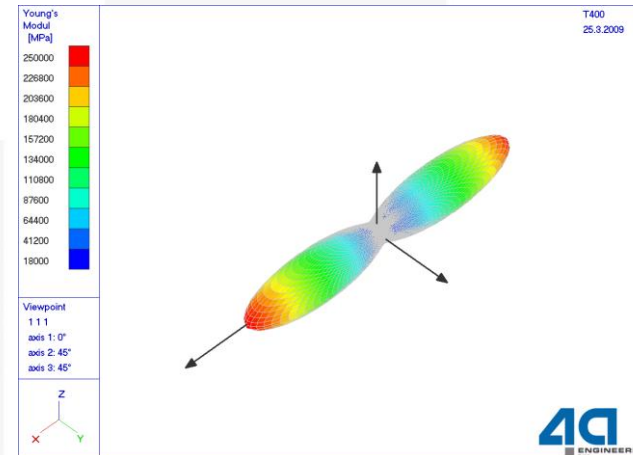

exemplary values without any warranty

Keyword format

CARD 7-8: matrix material

from material characterization (e.g. 4a impetus MPIP)

Card 7	1	2	3	4	5	6	7	8
Matrix	ROM	E	PR					
Units	kg/mm ³	GPa	-					
PP	0.9E-6	1.5	0.4					
PA6 dry	1.2E-6	3.2	0.35					
PA6 cond.	1.2E-6	2.0	0.35					

elasticity

Card 8	1	2	3	4	5	6	7	8
Matrix	SIGYT	ETAN			EPS0	C		
Units	GPa	GPa	-		1/ms	-		
PP	0.015	0.5			1.E-6	10		
PA6 dry	0.06	1.0			1.E-6	15		
PA6 cond.	0.04	0.8			1.E-6	10		

**visco
plasticity**

**Bilinear
+ Johnson
Cook**

exemplary values without any warranty

Keyword format

CARD 9: matrix material tables

Card 9	1	2	3	4	5	6	7	8
Variable	LCIDT				LCDI	UPF	LCIDT	Effective stress (Table)
Type	F				F	F	LCDI	Damage initiation (Table)
Default	0				0	0.0	UPF	Damage evolution parameter

Hardening

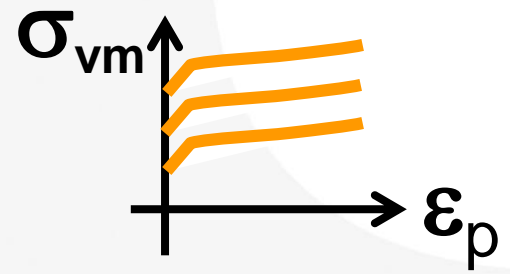

Damage Initiation

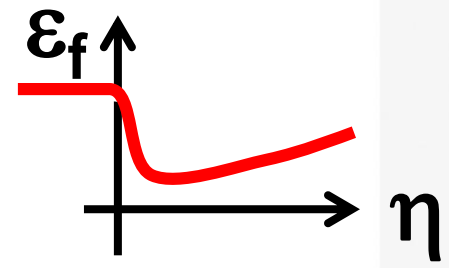

Damage Evolution

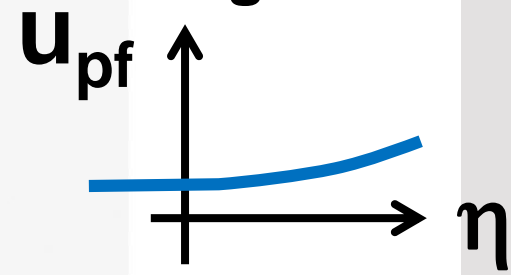

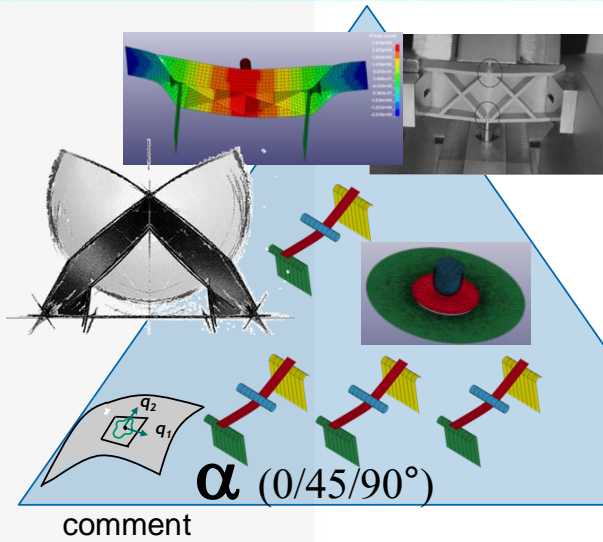
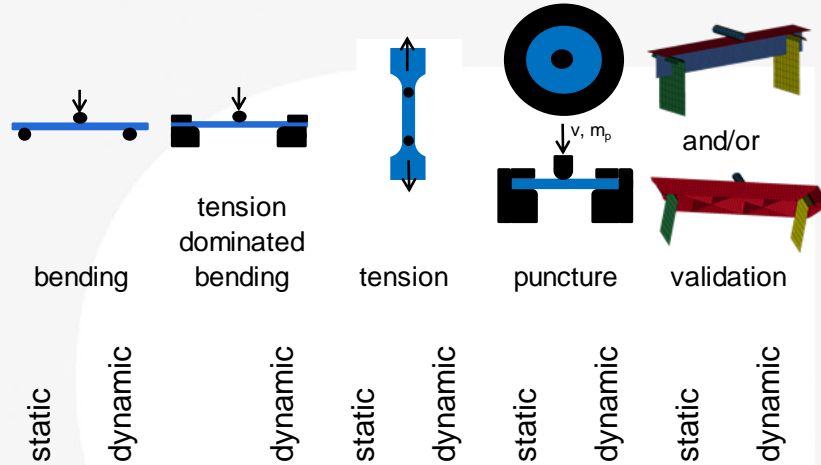

component validation

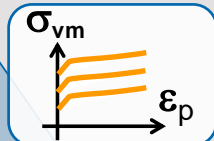
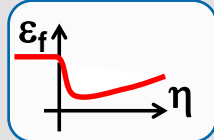

	static	dynamic	dynamic	static	dynamic	static	dynamic	static	dynamic	comment
*MAT_024	<input checked="" type="checkbox"/>	<input checked="" type="checkbox"/>								Materialcard for each direction
*MAT_157	<input checked="" type="checkbox"/>	<input checked="" type="checkbox"/>	<input checked="" type="checkbox"/>	<input checked="" type="checkbox"/>	<input checked="" type="checkbox"/>	<input checked="" type="checkbox"/>	<input checked="" type="checkbox"/>	<input checked="" type="checkbox"/>	<input checked="" type="checkbox"/>	μCT
*MAT_215	<input checked="" type="checkbox"/>	<input checked="" type="checkbox"/>	<input checked="" type="checkbox"/>	<input checked="" type="checkbox"/>	<input checked="" type="checkbox"/>	<input checked="" type="checkbox"/>	<input checked="" type="checkbox"/>	<input checked="" type="checkbox"/>	<input checked="" type="checkbox"/>	

Upcoming ISO Plate 120 x 80 x 2 mm



injected samples



Source: LS DYNA Forum 2016 - *MAT_4A_MICROMECH – micro mechanic based material model

*MAT_215 - *MAT_4A_MICROMECH

Material characterization

bending

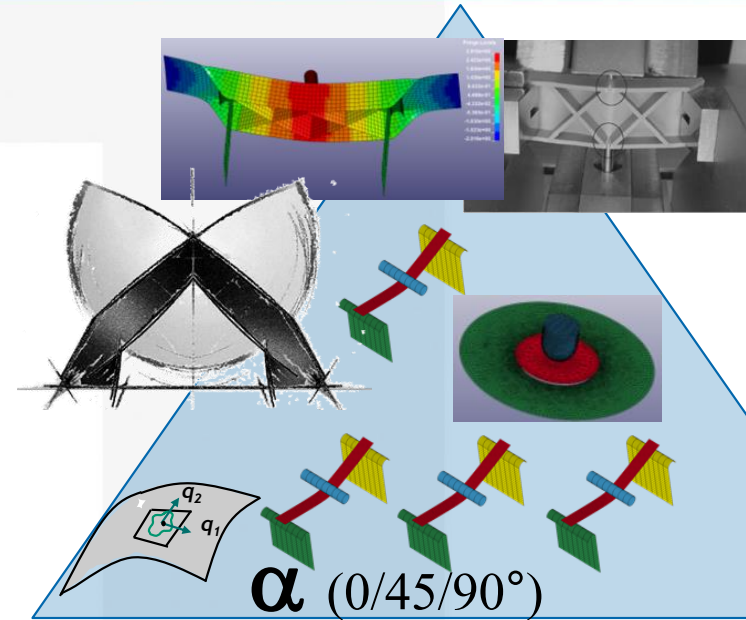
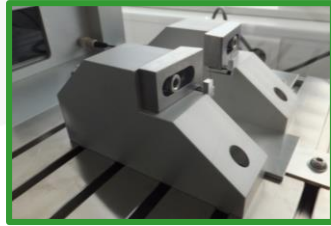

component validation

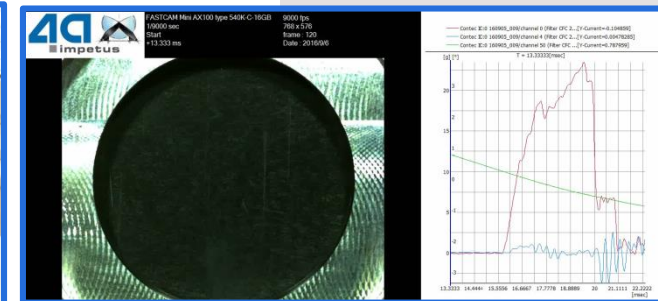
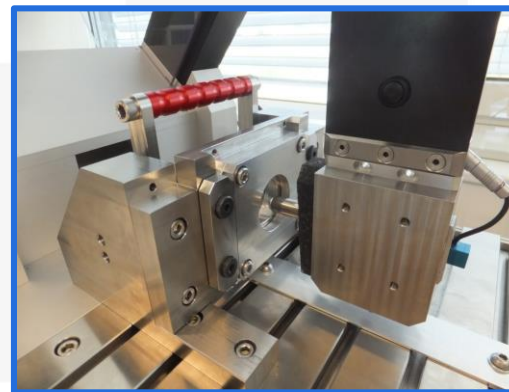
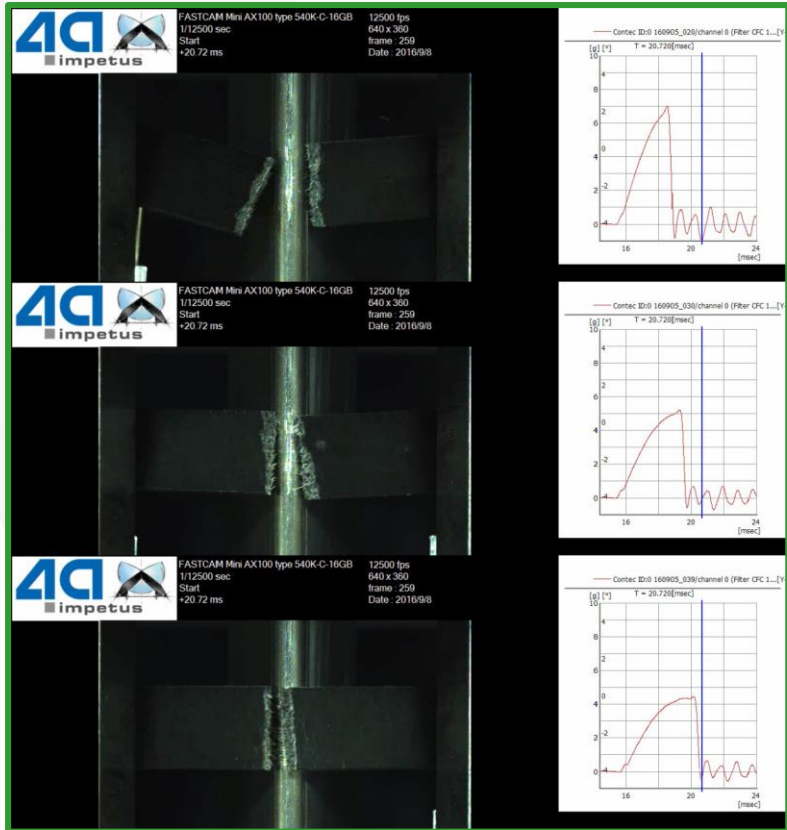
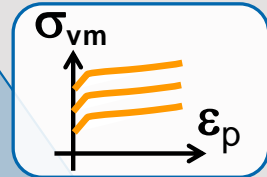
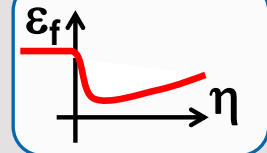

puncture test

Source: LS DYNA Forum 2016 - *MAT_4A_MICROMECH – micro mechanic based material model

*MAT_215 - *MAT_4A_MICROMECC

Material characterization

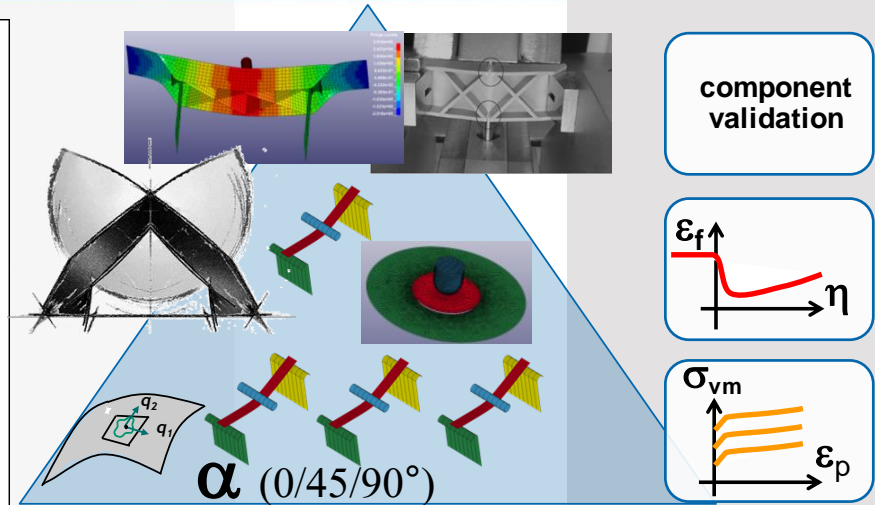
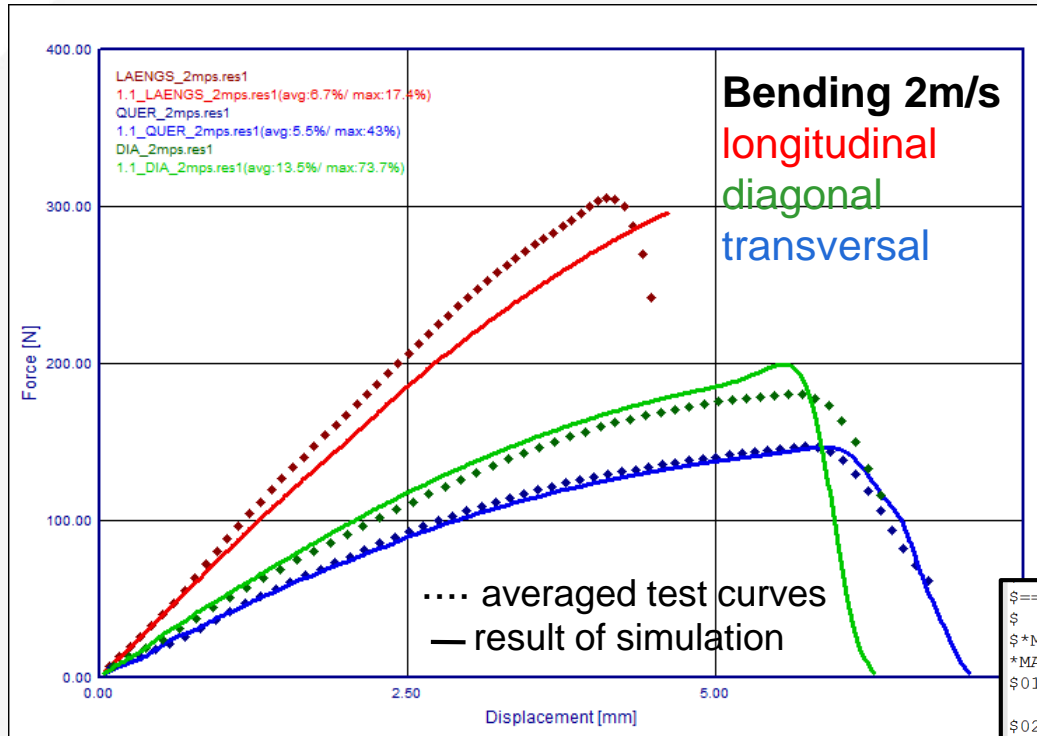

```

=====
$
$
$*MAT_215
*MAT_4A_MICROMECC
$01 mid mmopt bupd -- -- failm failf NUMINT
    1000000 1.0 0.01 -- -- 1. 0. -65.
$02 aopt macf xp yp zp a1 a2 a3
    0 0 0.0 0.0 0.0 1.0 0.0 0.0
$03 v1 v2 v3 d1 d2 d3 beta --
    0.0 0.0 0.0 0.0 0.0 1.0 0. --
$04 fvf -- fl fd -- a11 a22 --
    .115 .53. 1.0 .7 .25 --
$05 rof el et glt prt1 prtt -- --
    2.5899e-09 70000. 70000. 28759. 0.217 0.217 -- --
$06 xt -- -- -- -- -- -- SLIMXT NCYRED
    2800. -- -- -- -- -- 0.01 10
$07 rom e pr -- -- -- -- --
    9.1e-10 1500. 0.3 -- -- -- --
$08 sigyt etant -- -- eps0 c
    -- -- -- -- -- -- --
$09 LCST -- -- -- LCDI UPF
    1000000 -- -- 1000020 -1000026
=====
    
```

Source: LS DYNA Forum 2016 - *MAT_4A_MICROMECC – micro mechanic based material model

Material characterization

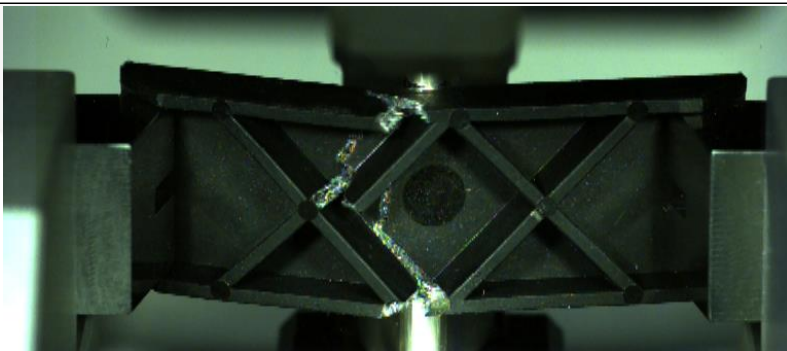
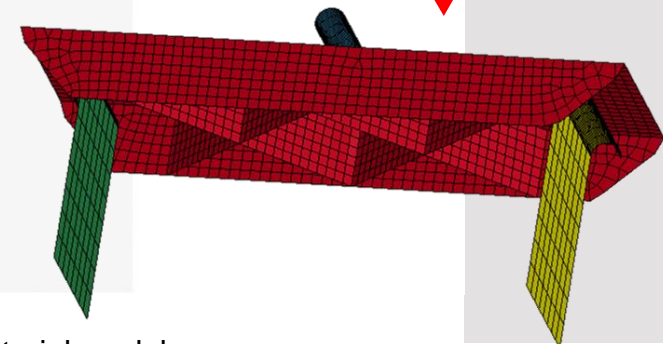
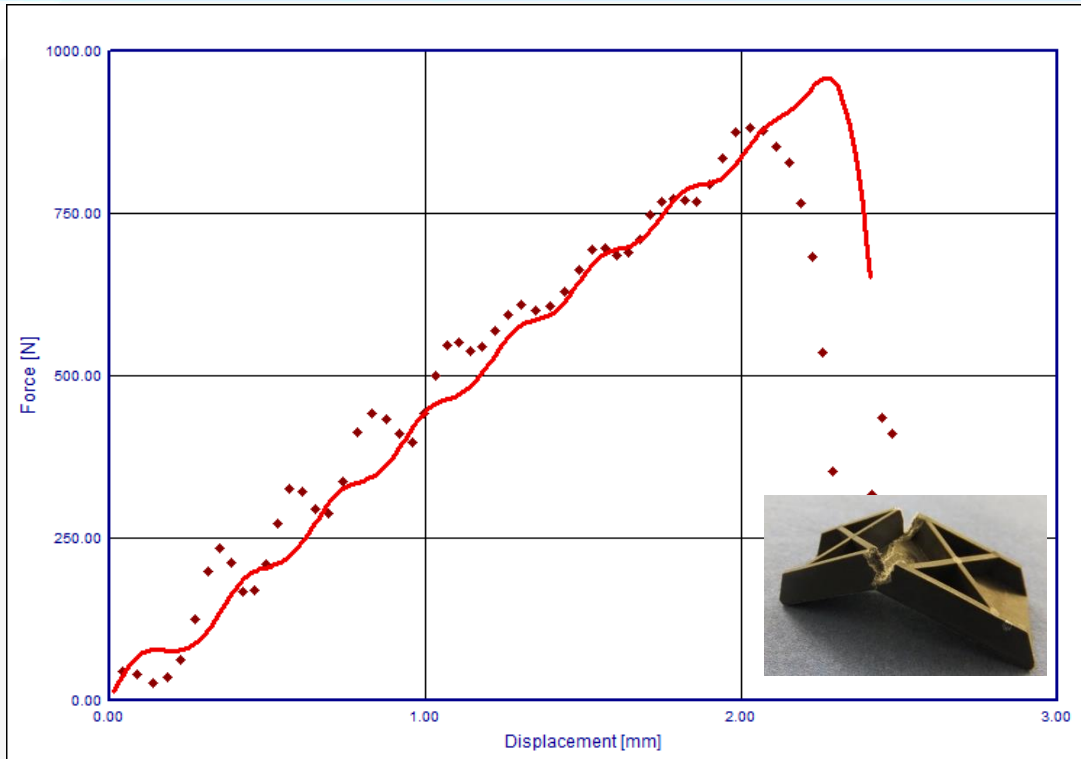

Source: LS DYNA Forum 2016 - *MAT_4A_MICROMECH – micro mechanic based material model

© 4a engineering GmbH, all rights reserved

*MAT_215 - *MAT_4A_MICROMECH

CPU time per integration point (SMP 1 CPU)

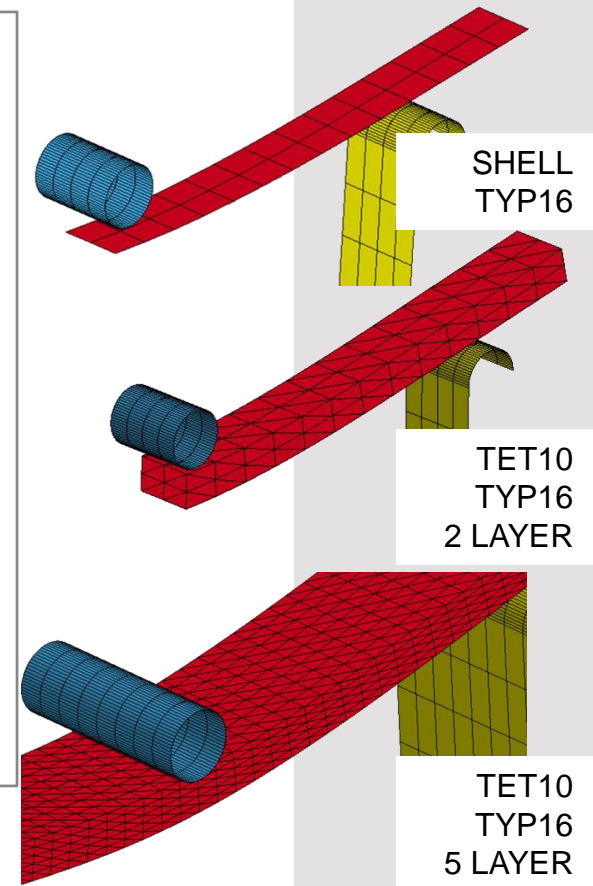
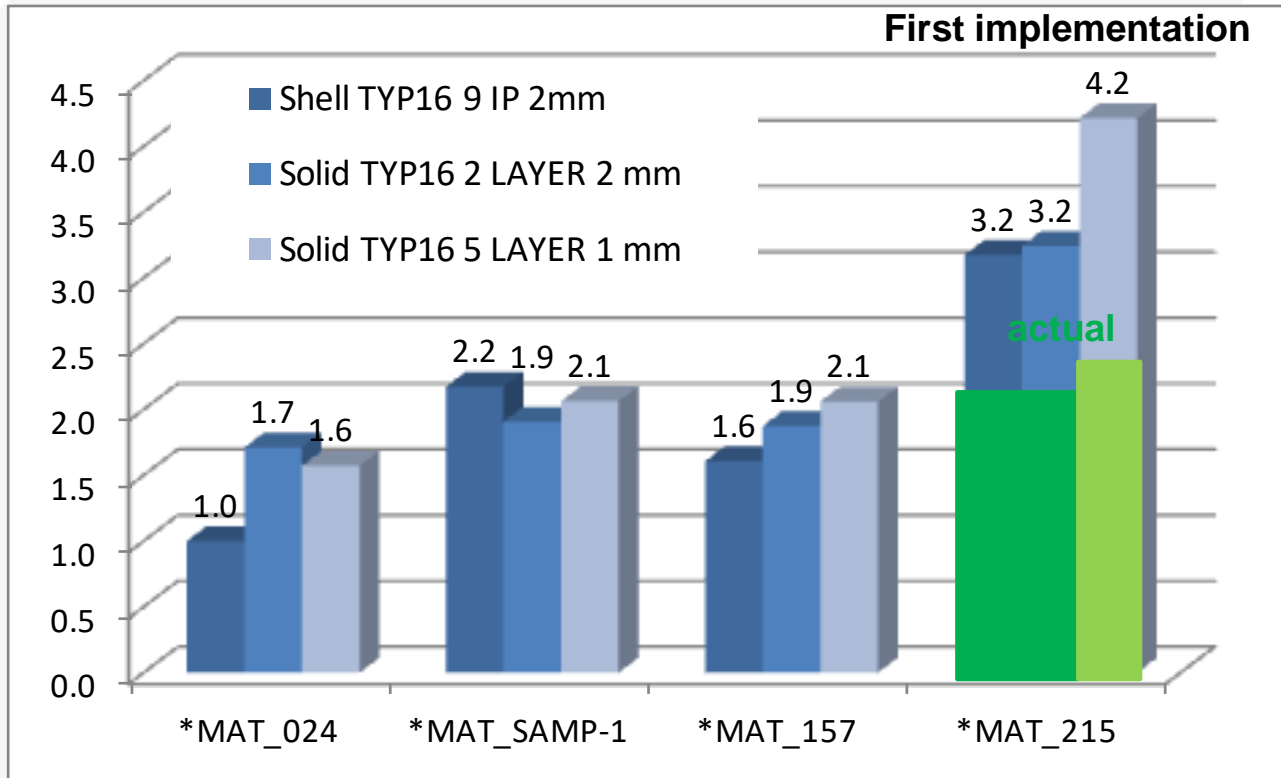

*MAT_215 - possible improvements

- timestep calculation (conservative implementation)
- compiler options – optimizations for cluster
- ...

Endless fibers - fabric

22	Orthotropic	None	None	None	Orientation dependent	Carbon, Glass, Kevlar endless & fabric
54/55	Orthotropic	None	Elastic Orthotropic	Strength	Chang-Chang/ Tsai-Wu Orientation dependent	
58	Orthotropic	None	Elastic Orthotropic	Strength, Stiffness	mod. Hashin Orientation dependent	
158	Orthotropic	None	Elastic Orthotropic	Visco-elasticity	Orientation dependent	
261	Orthotropic	None	Elastic Orthotropic	None	failure Pinho (Puck) Orientation dependent	
262	Orthotropic	None	Elastic Orthotropic	None	failure Camanho (Puck) Orientation dependent	

The influence of the manufacturing process on the material behavior (fiber orientation) is included in the process chain.

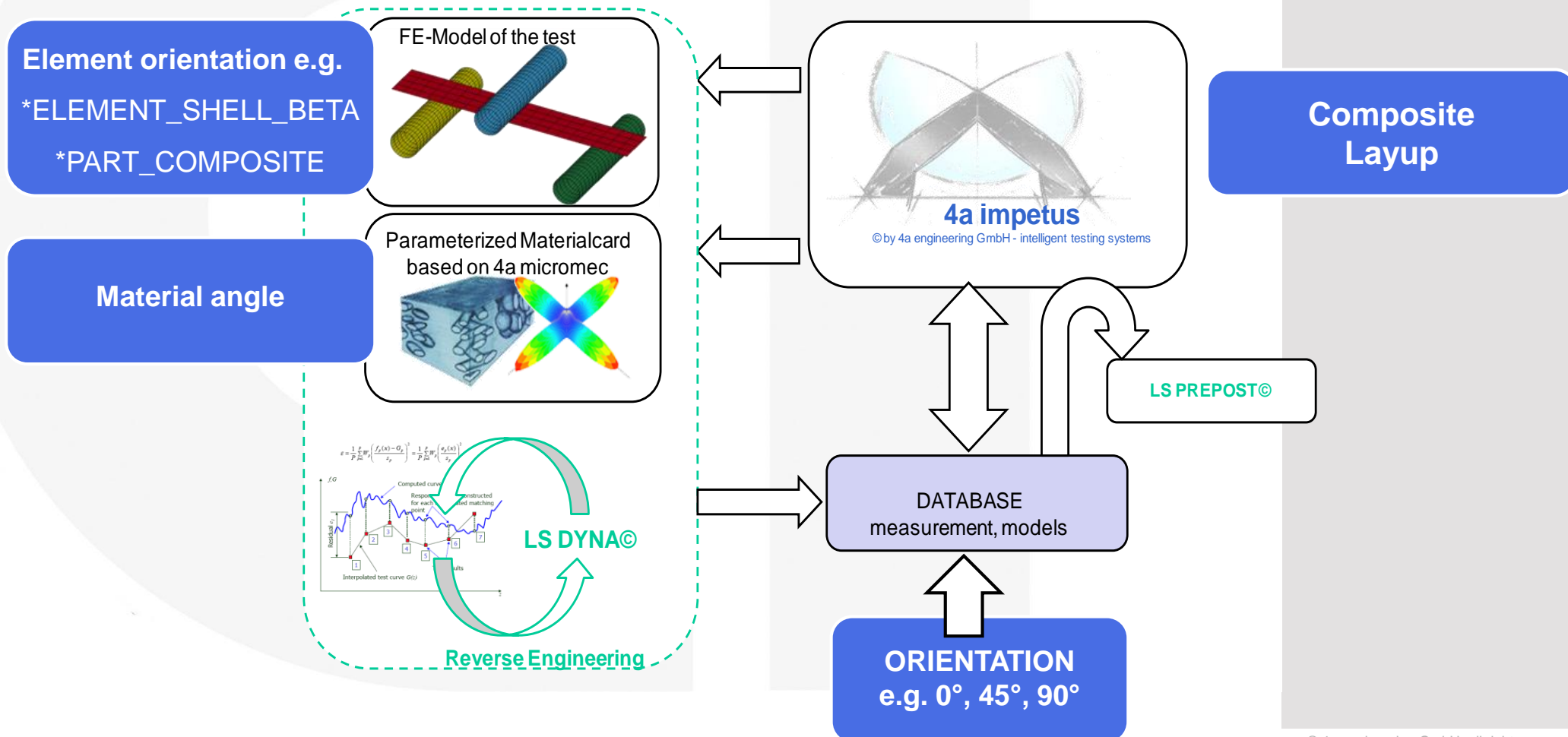

Composites

Typical test setup

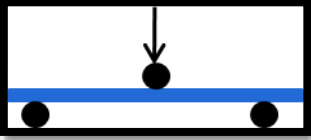
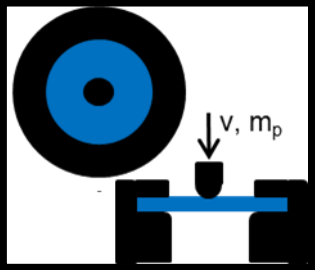
	specimen	0°	45°	90°
	== UD		static	
	≠ MD		static, cyclic	
	== UD		static, dynamic	
	≠ MD		static, dynamic	
	≠ MD		Puncture	

Material Card

Validation

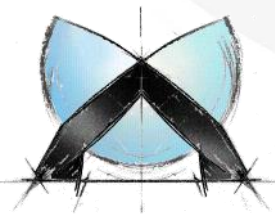

4a impetus - intelligent testing systems
powered by 4a engineering GmbH

Composites – Material characterization

Typical results for carbon fiber reinforced material

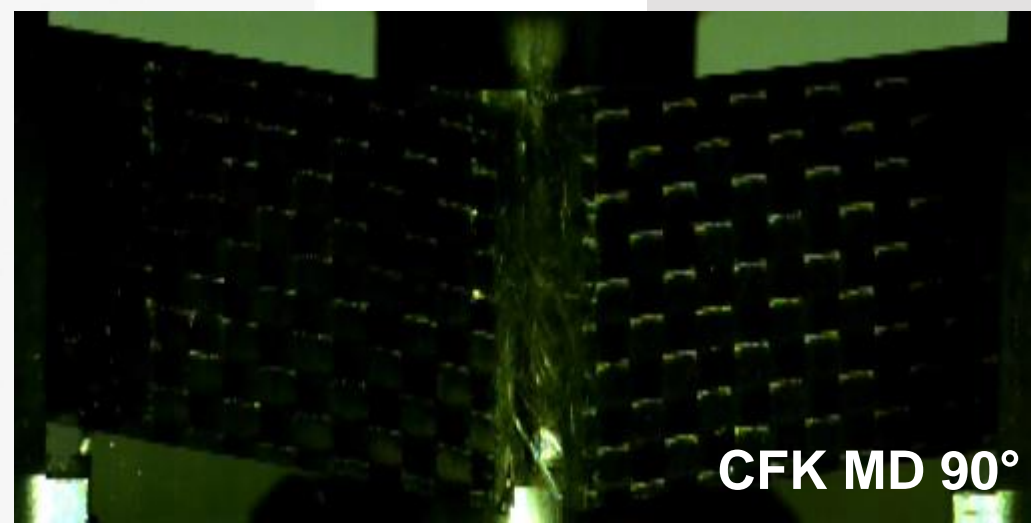
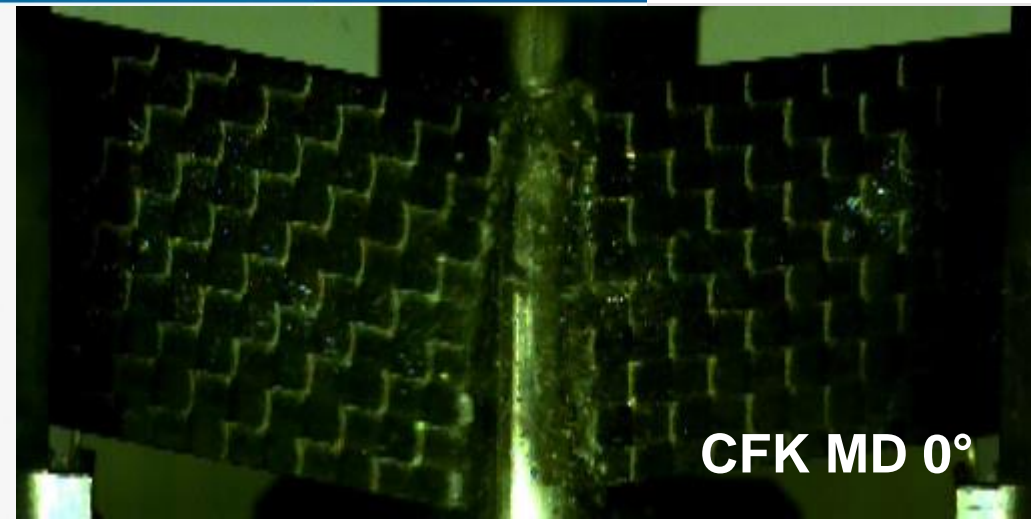
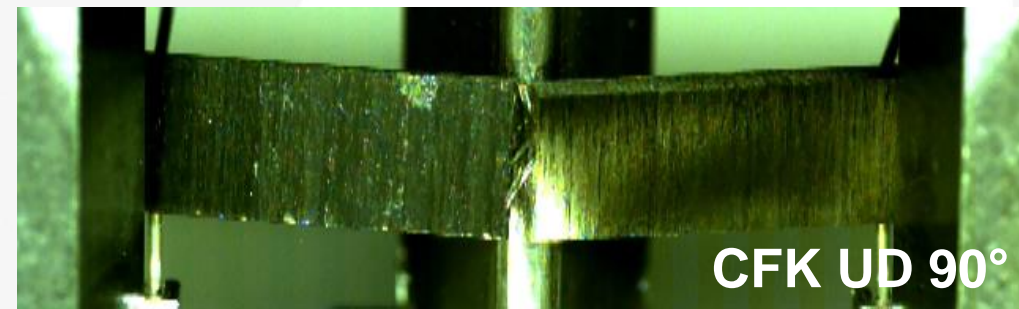
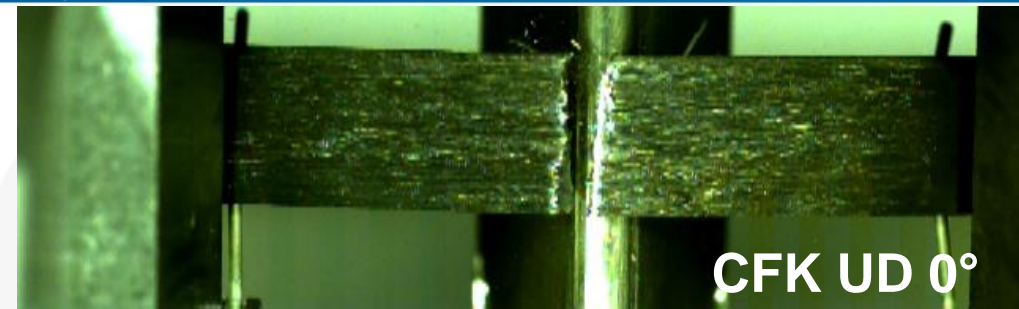

compression / tension strength [-]

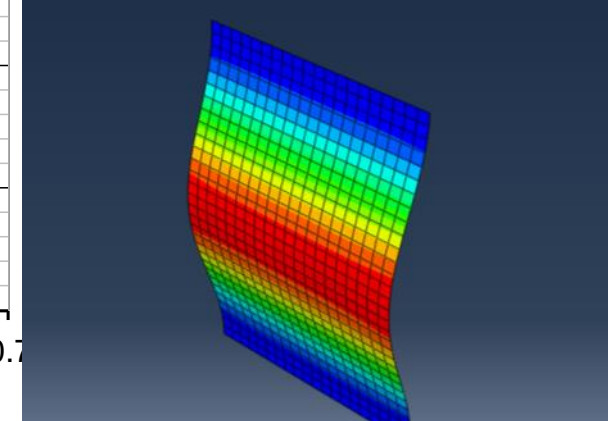
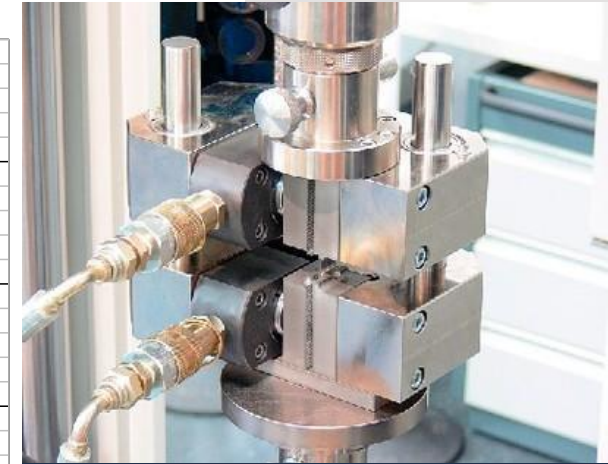
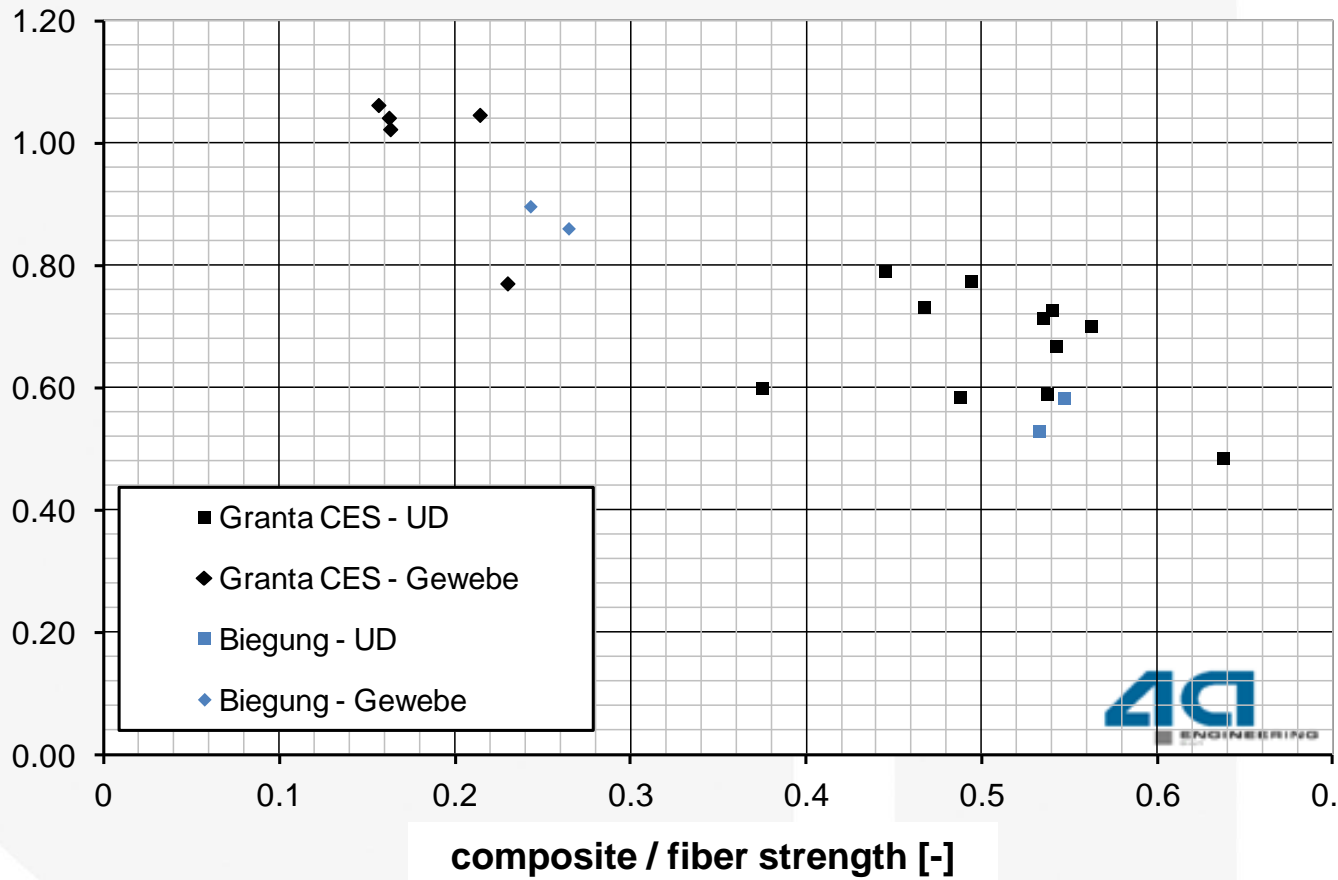

P. Reithofer (4a engineering GmbH) & B. Fellner (MAGNA STEYR Engineering Austria) - Materialcharakterisierung von Composites; 4a Technologietag 2015

© 4a engineering GmbH, all rights reserved

Composites

4a micromec: Current 4a impetus 3.4 version

Material behaviour	Implemented
Material source	Implemented
Elasticity	Not isotropic elastic
Plasticity	Not selected
Failure/Damage	Not selected
Material card	*MAT_ANISOTROPIC_ELASTIC_PLASTIC (*MAT_157)
Deformation	*MAT_COMPOSITE_DAMAGE (*MAT_022)
Damage/Failure	*MAT_ENHANCED_COMPOSITE_DAMAGE (*MAT_054)
Materialcard id	*MAT_LAMINATED_COMPOSITE_FABRIC (*MAT_058)
Density	*MAT_RATE_SENSITIVE_COMPOSITE_FABRIC (*MAT_158)
Plasticity	*MAT_LAMINATED_FRACTURE_DAIMLER_PINHO (*MAT_261)
Function (Hardening, Elastic curve form)	*MAT_LAMINATED_FRACTURE_DAIMLER_CAMANHO (*MAT_262)
Strain rate dependency	*MAT_ANISOTROPIC_ELASTIC_PLASTIC (*MAT_157)
Micromec	*MAT_MICROMECC (*MAT_215)
Fracture	*MAT_MICROMECC (*MAT_215)+Carbon
Postfracture	None

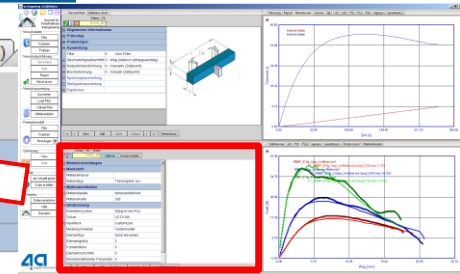

Material micromec implementation *MAT_022

Micromec	Implemented
Matrix	7500_MAT22
Density of the matrix	Chang Chang
E-Modulus	1000000
Poisson's ratio	1480
Yield strength	None
Strength at Break	None
Failure strain	Endless fiber reinforced plastics
Fiber	
Fillerlength	20000
Fillerdiameter	20
Phi or Psi	φ
Phi	58
Psi	71.7
Fillermaterial	T300
Orientation	
Fillerorientationtype	UD
Strength	
Strength evaluation	Fiber strength
XT	2300
XC	2000
Fracture	Composite
Postfracture	None

Matrix properties

Filler properties

Orientation

Strength

Idealization – *Part_Composite

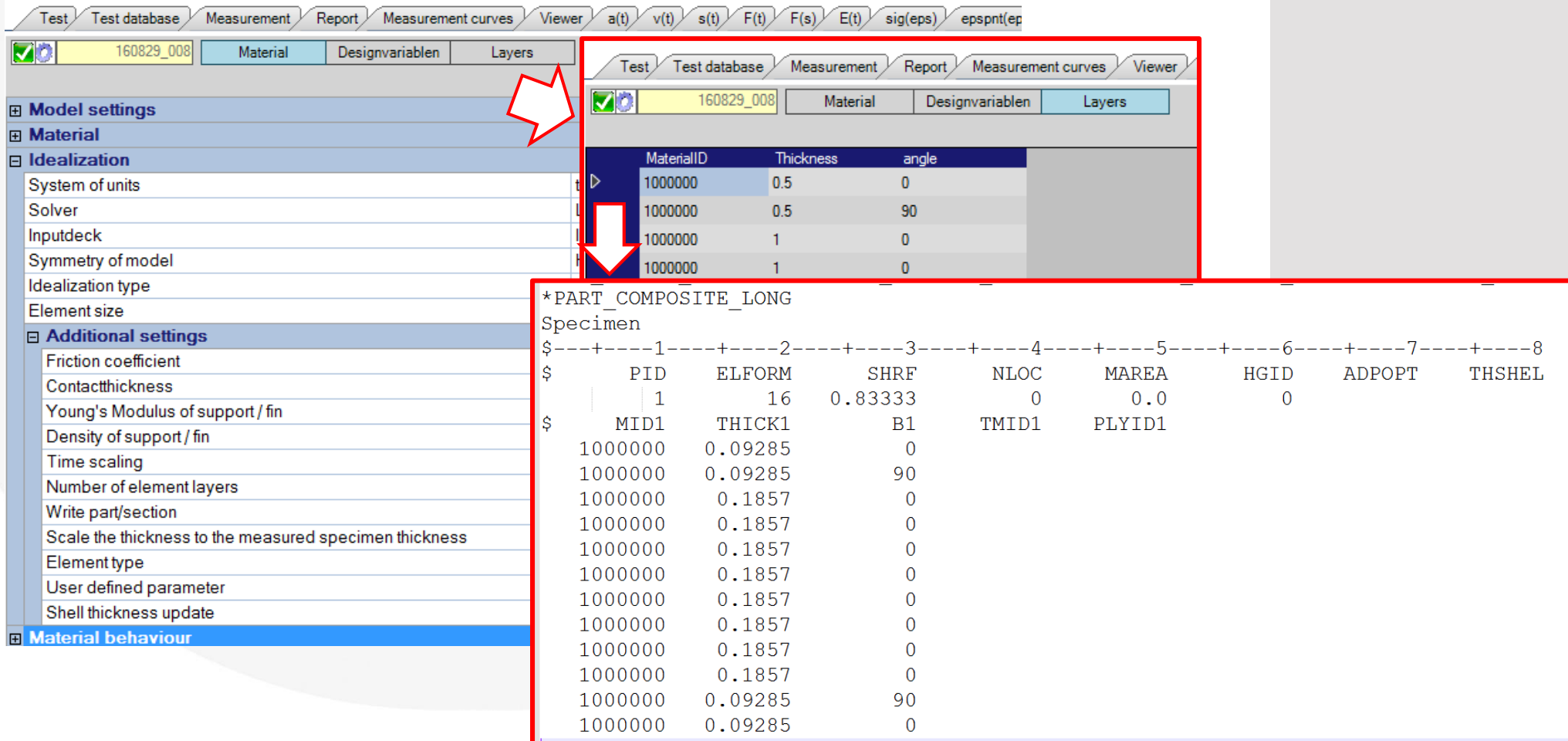

The screenshot shows the software interface for defining composite material properties. The 'Idealization' section is expanded, and the 'Additional settings' section is also expanded. A table of material properties is visible, with columns for MaterialID, Thickness, and angle. A red box highlights the table and the 'Additional settings' section.

MaterialID	Thickness	angle
1000000	0.5	0
1000000	0.5	90
1000000	1	0
1000000	1	0

```
*PART_COMPOSITE_LONG
Specimen
$---+---1---+---2---+---3---+---4---+---5---+---6---+---7---+---8
$   PID   ELFORM   SHRF   NLOC   MAREA   HGID   ADOPT   THSHEL
    1     16     0.83333  0     0.0     0
$   MID1   THICK1   B1     TMID1   PLYID1
1000000  0.09285  0
1000000  0.09285  90
1000000  0.1857   0
1000000  0.1857   0
1000000  0.1857   0
1000000  0.1857   0
1000000  0.1857   0
1000000  0.1857   0
1000000  0.1857   0
1000000  0.1857   0
1000000  0.09285  90
1000000  0.09285  0
```



Typical Design Variables for *MAT_022

Name	Start	const...	from	to	Variance	Condi...	Description
^ GroupName: 10_elasticity							
c_E11	MMEC	<input type="checkbox"/>	100000	180000	(NULL)		young modulus tensile in 1 direction
c_E22	MMEC	<input checked="" type="checkbox"/>	(NULL)	(NULL)	(NULL)		young modulus tensile in 2 direction
c_E33	MMEC	<input checked="" type="checkbox"/>	(NULL)	(NULL)	(NULL)		young modulus tensile in 2 direction
c_nue21	MMEC	<input checked="" type="checkbox"/>	(NULL)	(NULL)	(NULL)		poisson ration in 21 plane
c_nue31	MMEC	<input checked="" type="checkbox"/>	(NULL)	(NULL)	(NULL)		poisson ration in 31 plane
c_nue32	MMEC	<input checked="" type="checkbox"/>	(NULL)	(NULL)	(NULL)		poisson ration in 32 plane
c_G12	MMEC	<input checked="" type="checkbox"/>	(NULL)	(NULL)	(NULL)		shear modulus in 12 plane
c_G23	MMEC	<input checked="" type="checkbox"/>	(NULL)	(NULL)	(NULL)		shear modulus in 23 plane
c_G31	MMEC	<input checked="" type="checkbox"/>	(NULL)	(NULL)	(NULL)		shear modulus in 31 plane
^ GroupName: 51_failure							
fc_R11T	MMEC	<input checked="" type="checkbox"/>	(NULL)	(NULL)	(NULL)		
fc_R11C	MMEC	<input checked="" type="checkbox"/>	(NULL)	(NULL)	(NULL)		
fc_R22T	MMEC	<input checked="" type="checkbox"/>	(NULL)	(NULL)	(NULL)		
fc_R22C	MMEC	<input checked="" type="checkbox"/>	(NULL)	(NULL)	(NULL)		
fc_R12	MMEC	<input checked="" type="checkbox"/>	(NULL)	(NULL)	(NULL)		

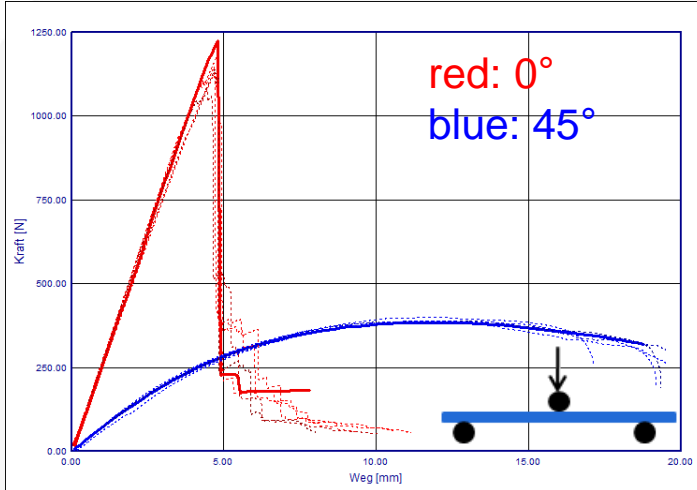
Orientation

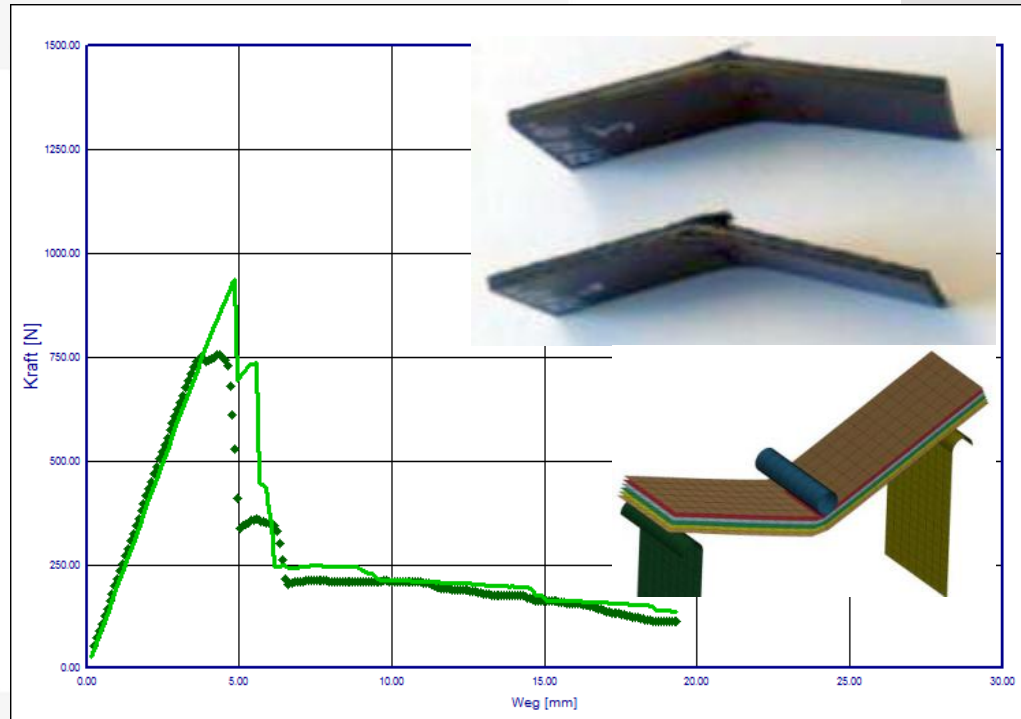

Multilayer Setup



Dynamic 4a impetus

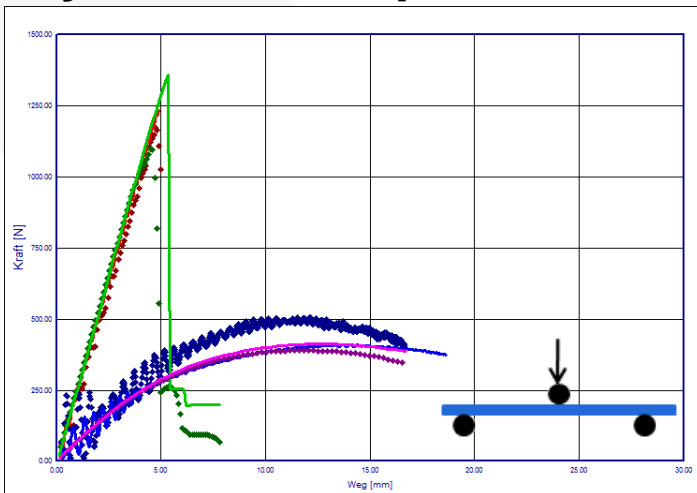

.... test
— simulation

P. Reithofer (4a engineering GmbH) & B. Fellner (MAGNA STEYR Engineering Austria) - Materialcharakterisierung von Composites; 4a Technologietag 2015

Mehrstufiger Ansatz

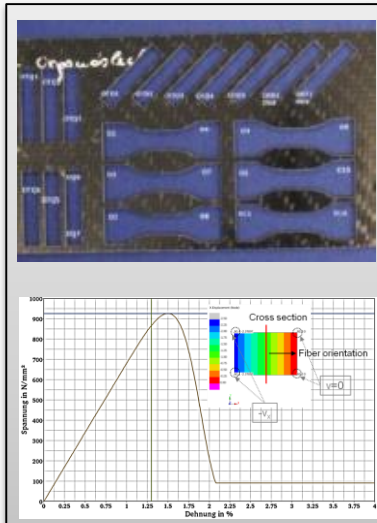

Werkstoff

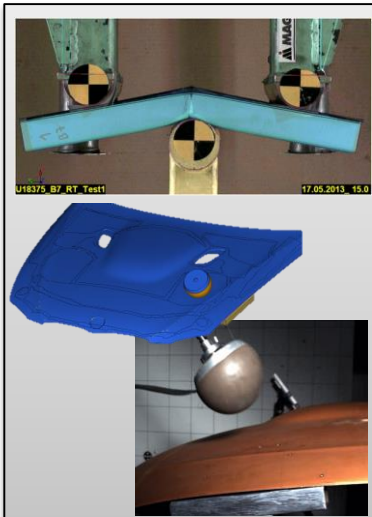

Bauteil

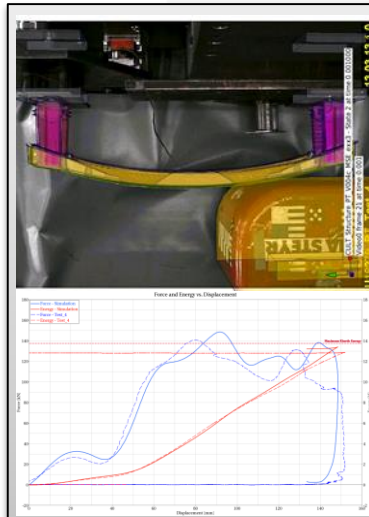

Modul

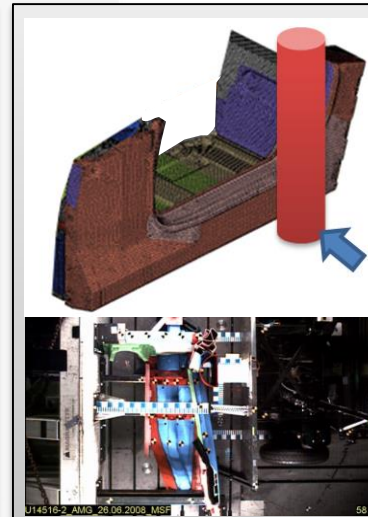

Fahrzeug
Teilbereich

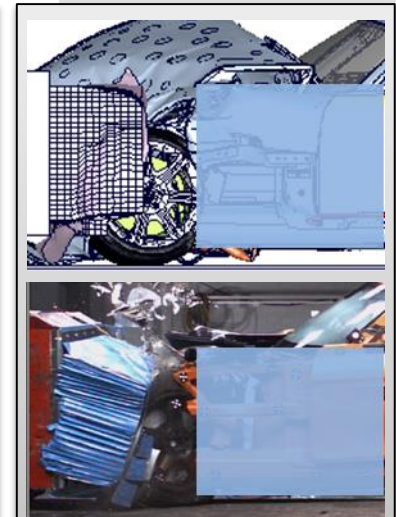

Gesamt-
fahrzeug

Composites – Validation

Composite Life Cell

Fahrzeugteilbereich – Crash

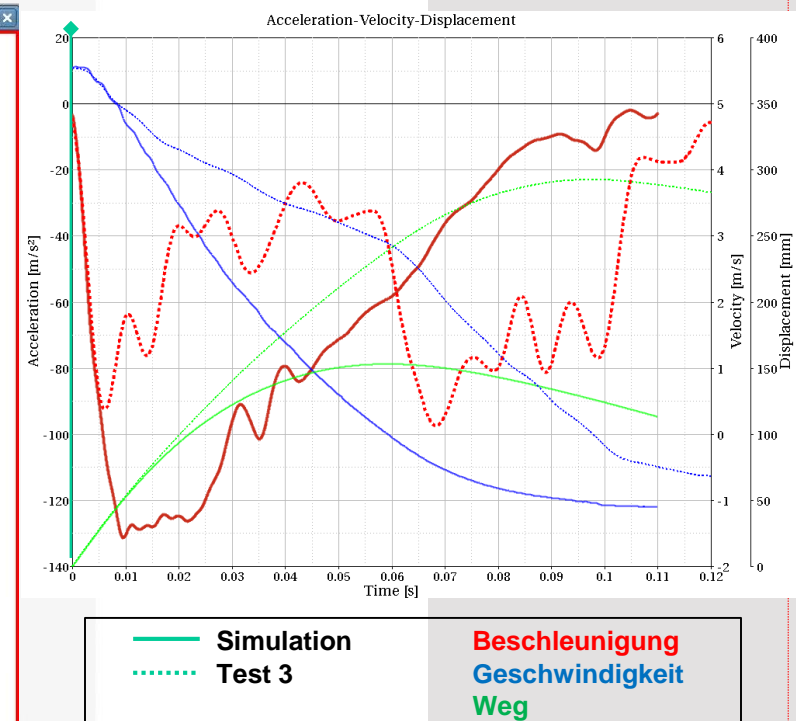
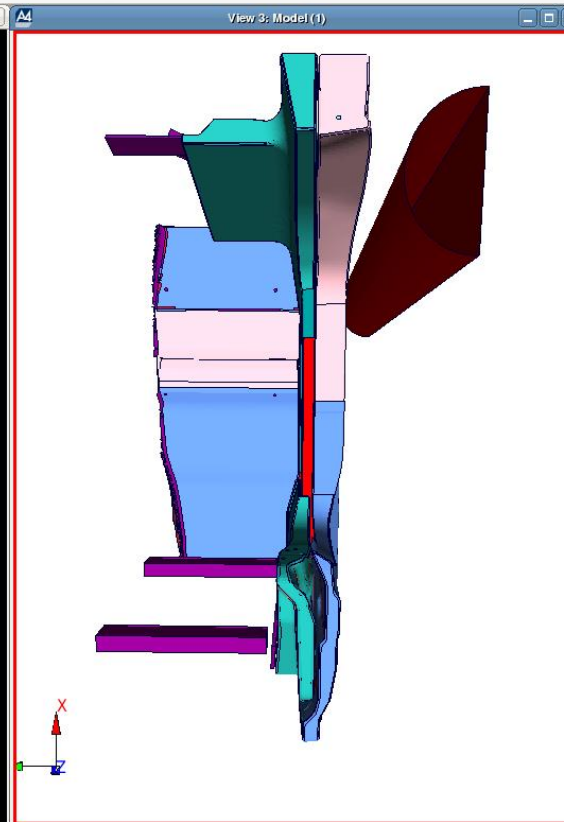
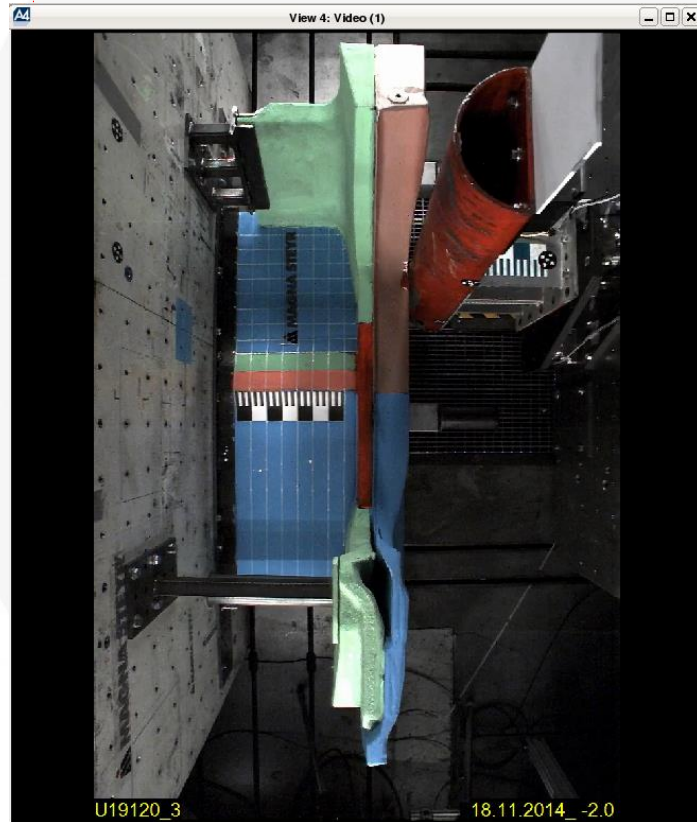

Werkstoff

Bauteil

Modul

Fahrzeug
Teilbereich

Gesamt-
fahrzeug

Composites – Validation

Composite Life Cell

Fahrzeugteilbereich – Crash

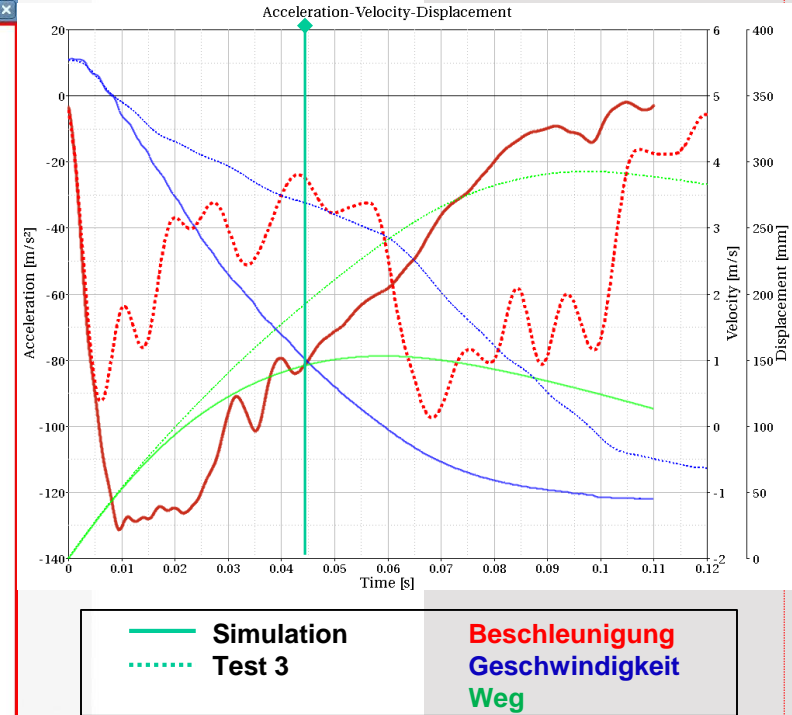
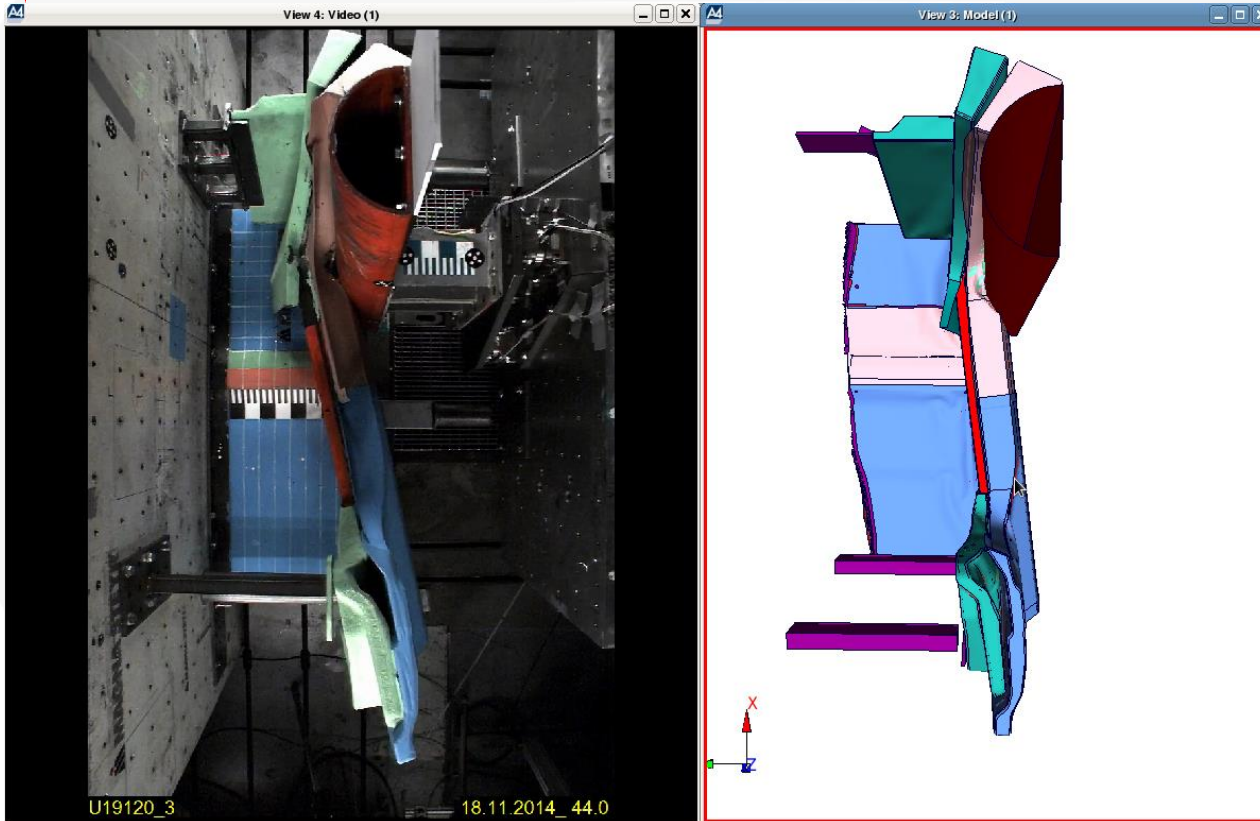

Werkstoff

Bauteil

Modul

Fahrzeug
Teilbereich

Gesamt-
fahrzeug

P. Reithofer (4a engineering GmbH) & B. Fellner (MAGNA STEYR Engineering Austria) - Materialcharakterisierung von Composites; 4a Technologietag 2015 GmbH, all rights reserved

Detail Analyse

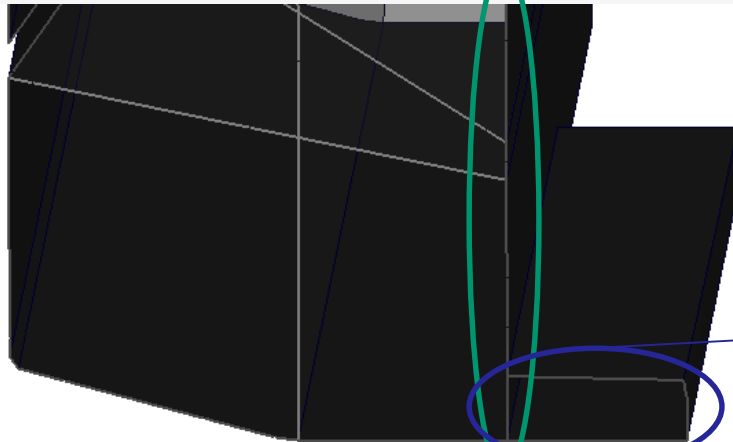

Schwellerprofil - Schnitt



Schwellerprofil deformiert



Real fiber structure



FE-model

Fiktives Beispiel:

Layered thin shell element
reicht nicht aus.
Stacked Shell Modell
lokal wieder notwendig



Werkstoff

Bauteil

Modul

Fahrzeug
Teilbereich

Gesamt-
fahrzeug

Summary & Outlook

Summary & Outlook

Numerical support – key enabler

Effort
Costs
Time

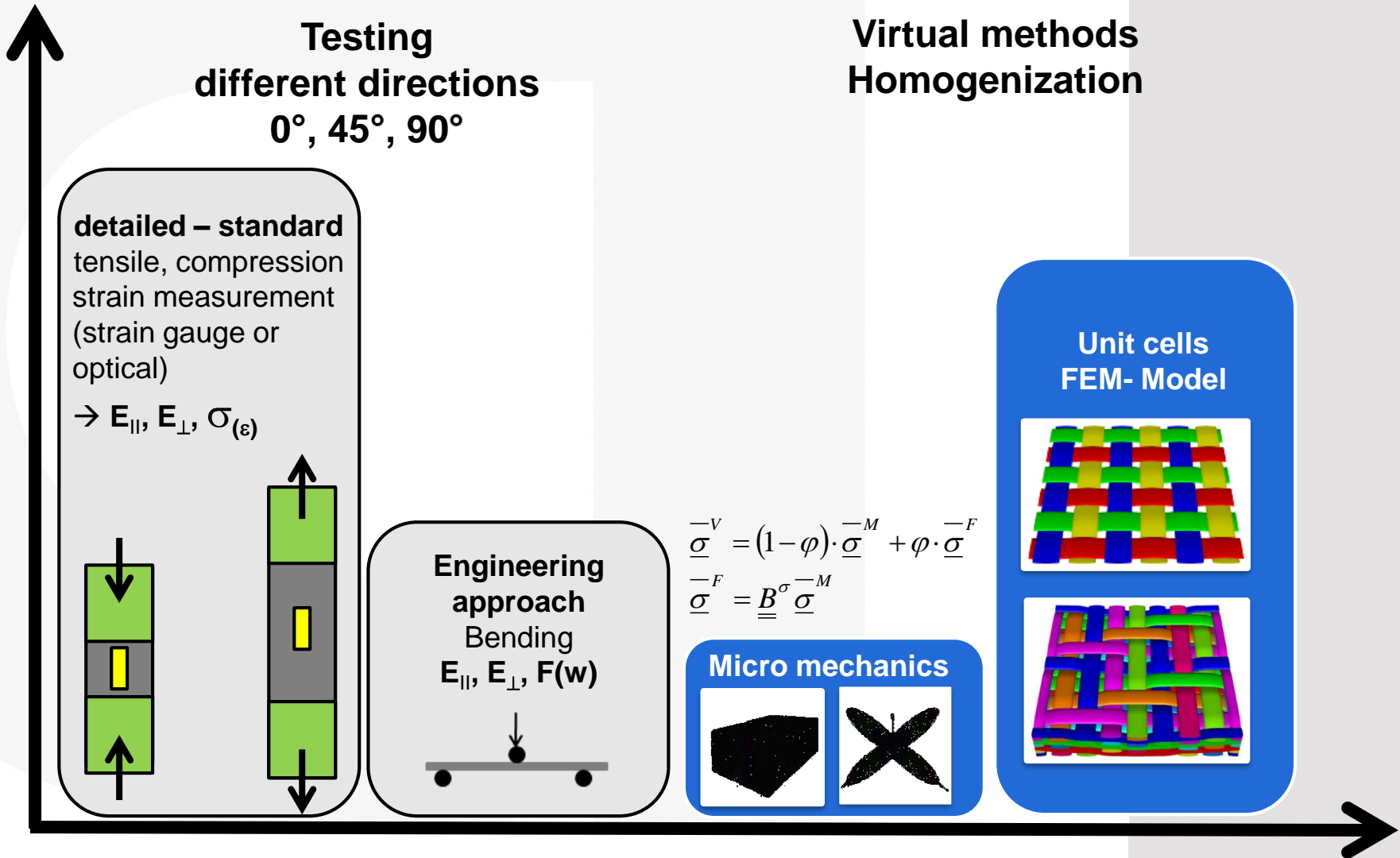

Summary & Outlook

Numerical support – key enabler

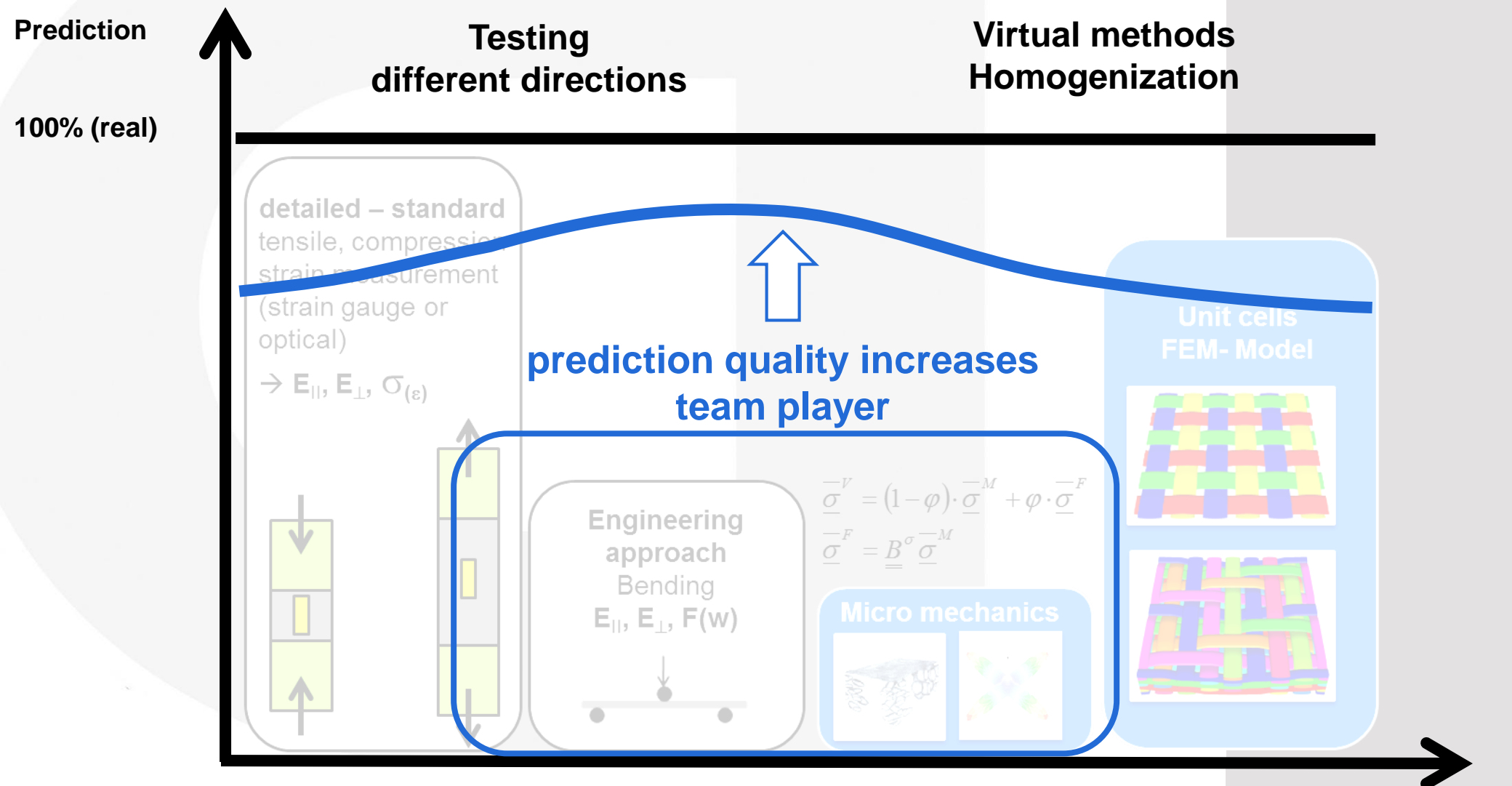

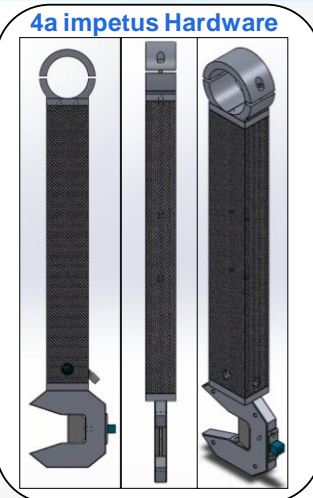

Spezifikationen	
Pendellarmlänge	500 mm
mögliche Prüfgeschwindigkeiten	0,5-4,4 m/s
maximal zulässige Zusatzmassen	4000 g
maximal zulässige Prüfenergie	50J

**Highspeed Video
Composites
Puncture test
Component testing**

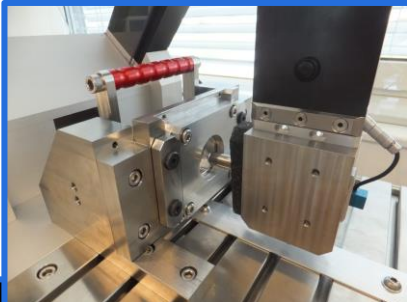

FASTCAM Mini AX100 type 540K C-16GB
9000 fps
1/9000 sec
768 x 576
Start
-19.067 ms

9000 fps
768 x 576
frame: 177
Date: 2016096

Force vs. Displacement: $F [N]$ vs. $s [mm]$

Energy vs. Displacement: $E [J]$ vs. $s [mm]$

Time: $T = 19.6660 [msec]$

Workflow - process automation

Automated_Optimization

ID	Name	Optimization/Validation	Status	VP Autovalue
141204_003	Celstran - E-Modul	Validation	●	<input type="checkbox"/>
141204_005	Celstran - plast	Optimization	●	<input type="checkbox"/>
▶ 141204_006	Celstran - strain rate	Optimization	●	<input checked="" type="checkbox"/>
141204_007	Celstran - validation	Validation	●	<input type="checkbox"/>

calc max strain
 calc strainrates

DV	Autovalue	141204_003	141204_005	141204_006	141204_007
▶ e_E	6392.7	6359.221	PRUN(c)	PRUN(c)	PRUN(c)
s_ET	12.219	n.a.	1000	1000	1000
s_h	69.887	n.a.	AUTO	PRUN(c)	PRUN(c)
s_y	69.887	n.a.	AUTO	PRUN(c)	PRUN(c)
v_epspkt	0.001	n.a.	AUTO(c)	AUTO(c)	PRUN(c)
v_p	11.855	n.a.	AUTO(c)	AUTO	PRUN

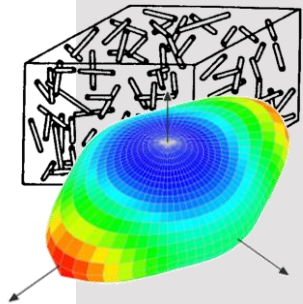
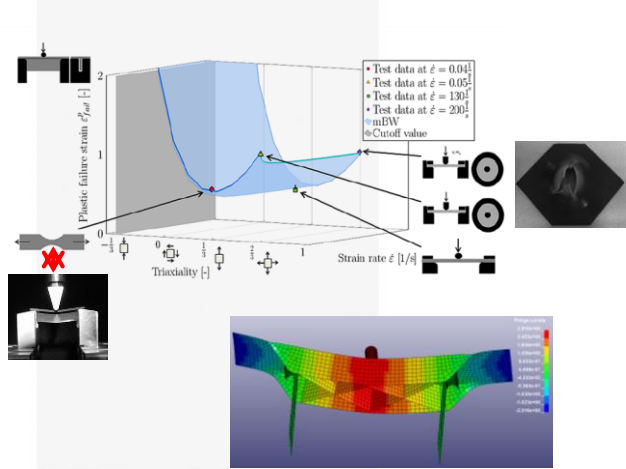

**Failure
Anisotropy
Validation**

Thank you for your attention!

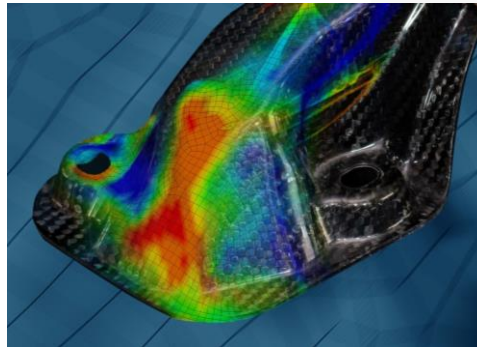

14th **4a**
TECHNOLOGIETAG

23.- 24. March 2017
in Schladming, Austria

„Light weight applications & Composites“
More information: <http://technologietag.4a.co.at/>